

would require that the Sternheimer factors be known to an accuracy of much better than 10% for surface ions. Unfortunately, this is not the case at present.

The clearest trends which are obtained from our calculations occur at positive ion sites in the potassium halides, and are presented in Figs. 1(a) and (b), where the efg's with and without BFD's lattice distortion are plotted against bulk lattice constant for KCl, KBr, and KI. For RbCl, RbBr, and RbI, the same plots do not exhibit any marked differences between distorted and undistorted cases.

Perhaps the simplest test of the BFD model is provided by KI. For "(+) in" sites of KI the surface distortion correction to the efg changes the sign of the efg. This is a qualitative feature and is independent of the value of the Sternheimer factor. It would thus provide the simplest experimental test of the BFD model, for on the basis of this model our work shows that the efg has the same sign at "(+) in" and "(+) out" sites in KI whereas ignoring surface lattice distortion the efg would have opposite signs at these two sites.

THE JOURNAL OF CHEMICAL PHYSICS VOLUME 48, NUMBER 4 15 FEBRUARY 1968

## Proton Affinities of $\text{H}_2\text{S}$ and $\text{H}_2\text{O}$

J. L. BEAUCHAMP\* † AND S. E. BUTTRILL, JR. †

*Department of Chemistry, Stanford University, Stanford, California*

(Received 9 August 1967)

Ion cyclotron single- and multiple-resonance spectroscopy have been used to identify and examine the energetics of ion-molecule reactions in which  $\text{H}_3\text{O}^+$  and  $\text{H}_3\text{S}^+$  are involved either as product or reactant. The reactions observed provide narrow limits for the gas-phase proton affinities of these species, giving  $164 \pm 4$  kcal/mole for  $\text{H}_2\text{O}$  and  $178 \pm 2$  kcal/mole for  $\text{H}_2\text{S}$ .

### I. INTRODUCTION

The proton affinity (PA) of a molecule (M) is defined as the negative of the enthalpy change for the reaction

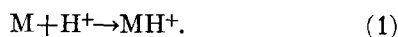

The hydrogen affinity (HA) can be similarly defined as the negative of the enthalpy change for the reaction

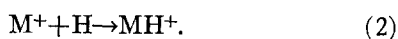

From thermochemical considerations the relations

$$\text{PA}(\text{M}) = \Delta H_f(\text{M}) + \Delta H_f(\text{H}^+) - \Delta H_f(\text{MH}^+), \quad (3)$$

$$\text{HA}(\text{M}^+) = \Delta H_f(\text{M}^+) + \Delta H_f(\text{H}) - \Delta H_f(\text{MH}^+), \quad (4)$$

$$\text{PA}(\text{M}) - \text{HA}(\text{M}^+) = \text{IP}(\text{H}) - \text{IP}(\text{M}), \quad (5)$$

are obtained where  $\text{IP}(\text{M})$  is the ionization potential of species M. As defined in Eq. (2) the hydrogen affinity is simply the hydrogen bond strength in the ion,  $\text{D}(\text{M}^+-\text{H})$ .

Previously determined values of the proton affinities of water have exhibited considerable disparity. The value  $\text{PA}(\text{H}_2\text{O}) = 168 \pm 7$  kcal/mole has been obtained based on crystal-lattice energies (including the effects

of hydrogen bonding) by Sokolov *et al.*<sup>1</sup> Tal'roze and Frankevich<sup>2</sup> have used the fact that the reaction

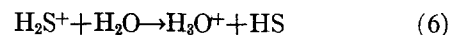

is observed while the reaction

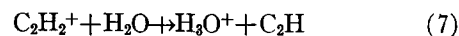

is not observed to derive the limits  $163 \text{ kcal/mole} < \text{PA}(\text{H}_2\text{O}) < 172 \text{ kcal/mole}$  by assuming that, because it is not observed, Reaction (7) is endothermic. Van Raalte and Harrison<sup>3</sup> have recently considered the mechanism and energetics of  $\text{H}_3\text{O}^+$  formation by electron impact in the mass spectra of alcohols, esters, and ethers. Their results are summarized in Table I. The average of their values for  $\Delta H_f(\text{H}_3\text{O}^+)$  and Eq. (3) give  $\text{PA}(\text{H}_2\text{O}) = 151 \pm 3$  kcal/mole. Hobrock and Kiser<sup>4-6</sup> have similarly determined  $\text{PA}(\text{H}_2\text{S}) = 199 \pm 2$  kcal/mole from the appearance potential of  $\text{H}_3\text{S}^+$  in the mass spectra of several sulfides (Table I). While the electron-impact data used to obtain  $\text{PA}(\text{H}_2\text{O})$  and  $\text{PA}(\text{H}_2\text{S})$  are self-consistent, this is sometimes the

<sup>1</sup> S. T. Vetchinkin, I. I. Pshenichnov, and N. B. Sokolov, J. Phys. Chem. Moscow **33**, 1269 (1959).

<sup>2</sup> V. L. Tal'roze and E. L. Frankevich, Dokl. Akad. Nauk SSSR, **111**, 376 (1956).

<sup>3</sup> D. Van Raalte and A. G. Harrison, Can. J. Chem. **41**, 3118 (1963).

<sup>4</sup> B. G. Hobrock and R. W. Kiser, J. Phys. Chem. **66**, 1648 (1962).

<sup>5</sup> B. G. Hobrock and R. W. Kiser, J. Phys. Chem. **67**, 648 (1963).

<sup>6</sup> Reference 5, p. 1283.

\* On travelling guidance from Harvard University.

† National Science Foundation Predoctoral Fellows.

TABLE I. Appearance potentials and heats of formation of  $H_3O^+$  and  $H_3S^+$ .

$H_3X^+$	Parent compound	Appearance potential $A(H_3X^+)$ kcal/mole	Postulated neutral products	$\Delta H_f(H_3X^+)$ kcal/mole	Ref.
$H_3O^+$	s-Propanol	310 $\pm$ 3	$CH_3 + C_2H_2$	158 $\pm$ 3	3
	s-Butanol	308 $\pm$ 3	$C_2H_5 + C_2H_2$	158 $\pm$ 3	3
	s-Pentanol	308 $\pm$ 3	$N-C_3H_7 + C_2H_2$	156 $\pm$ 3	3
	3-Me-2-butanol	304 $\pm$ 3	$i-C_3H_7 + C_2H_2$	154 $\pm$ 3	3
	Ethanol	277 $\pm$ 3	$C_2H_3$	156 $\pm$ 3	3
	n-Propanol	292 $\pm$ 3	$C_3H_3 + H_2$	155 $\pm$ 3	3
	Diethyl ether	304 $\pm$ 3	$C_2H_5 + C_2H_2$	164 $\pm$ 3	3
	Ethyl formate	302 $\pm$ 3	$HCO + C_2H_2$	159 $\pm$ 3	3
	Isopropyl formate	317 $\pm$ 3	$CH_3 + CO + C_2H_2$	159 $\pm$ 3	3
$H_3S^+$	2-Thiabutane	348 $\pm$ 5	$CH_2 + C_2H_2 + H\cdot$	160 $\pm$ 5	4
	2-Thiapentane	360 $\pm$ 5	$CH_2 + C_3H_4 + H\cdot$	174 $\pm$ 5	4
	4-Thia-1-pentene	341 $\pm$ 5	$CH + C_3H_4$	163 $\pm$ 5	5
	3-Thiapentane	360 $\pm$ 5	$2C_2H_3 + H\cdot$	160 $\pm$ 5	6

result of selecting the appropriate neutral products. It seems reasonable that the neutral products obtained when  $H_3O^+$  is produced by electron-impact from diethyl ether should be the same as those obtained when  $H_3S^+$  is produced from 3-thiapentane. As can be seen from Table I, the neutral products used to calculate  $\Delta H_f(H_3O^+)$  from the appearance potential of  $H_3O^+$ ,  $A(H_3O^+)$ , in diethyl ether are not the same as the neutral products used to calculate  $\Delta H_f(H_3S^+)$  from  $A(H_3S^+)$  in 3-thiapentane. If  $\Delta H_f(C_2H_5\cdot + C_2H_2) = 81$  kcal/mole is used instead of  $\Delta H_f(2C_2H_3 + H\cdot) = 180$  kcal/mole to calculate  $\Delta H_f(H_3S^+)$ , the value obtained is 259 kcal/mole instead of 160 kcal/mole.

In view of the discrepancies between the crystal lattice and electron-impact values, we have determined the proton affinities of water and hydrogen sulfide by a technique similar to that used by Tal'roze. Our method, however, does not assume that a reaction which is not observed is endothermic. In this study we have employed ion-cyclotron multiple resonance<sup>7,8</sup> to identify ion-molecule reactions and probe their energetics.

## II. EXPERIMENTAL

The ion-cyclotron resonance spectrometer<sup>9</sup> with modifications for multiple-resonance experiments has been described in a previous publication.<sup>8</sup> Figure 1 shows a cutaway view of the cyclotron resonance cell. Ions are formed by the electron beam in the source region and drifted by crossed electric and magnetic fields into the resonance region where they are detected by measuring their rf power absorption with a marginal

oscillator. The electron beam is parallel to the magnetic field. The dimensions of the cell are  $2.54 \times 2.54 \times 12.7$  cm. The distance from the electron beam to the resonance region is 2.54 cm and the length of the resonance region is 6.35 cm. The applied drift voltages are such that the ion-transit times through the source and resonance regions are 0.1–1.0 msec and 1.0–10.0 msec, respectively. Under these conditions a reaction with a rate constant of  $0.3 \times 10^{-10}$  cm<sup>3</sup> molecule<sup>-1</sup>·sec<sup>-1</sup> will give a product-ion intensity amounting to approximately 10% of the parent-ion intensity at  $8 \times 10^{-5}$  torr and with an ion-transit time of one millisecond. Since proton-transfer reactions typically have thermal rates of  $10^{-9}$  cm<sup>3</sup> molecule<sup>-1</sup>·sec<sup>-1</sup>,<sup>10</sup> they are easily observed. The method of connecting the irradiating oscillator for double-resonance experiments indicated in Fig. 1 effectively decouples the observing and irradiating fields. The irradiation is applied only in the resonance region of the cell.

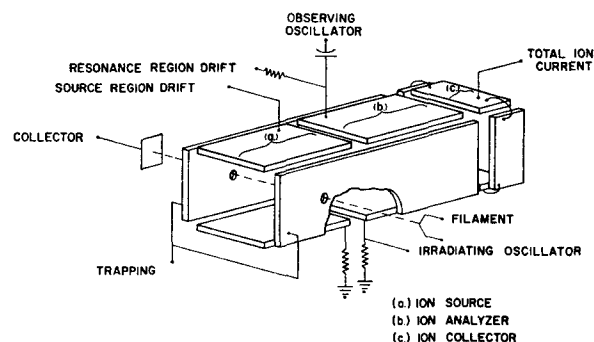

FIG. 1. Cutaway view of ion-cyclotron resonance cell. The magnetic field is collinear with the electron beam.

<sup>7</sup> L. R. Anders, J. L. Beauchamp, R. C. Dunbar, and J. D. Baldeschwieler, *J. Chem. Phys.* **45**, 1062 (1966).

<sup>8</sup> J. L. Beauchamp, L. R. Anders, and J. D. Baldeschwieler, *J. Am. Chem. Soc.* **89**, 4569 (1967).

<sup>9</sup> The basic spectrometer used in this study was designed by Dr. P. L. Llewellyn and was constructed by Varian Associates, Palo Alto, Calif.

<sup>10</sup> A. G. Harrison, J. J. Myher, and J. C. J. Thynne, in *Ion-Molecule Reactions in the Gas Phase*, P. J. Ausloos, Ed. (American Chemical Soc., Washington, D.C., 1966), p. 150.

The gases employed were of high purity from commercial sources. When impurities were detected in the low-pressure mass spectrum they were eliminated by vacuum distillation and freeze-pump-thaw cycles. The perdeutero methane (99.5 atom %) was obtained from Merck, Sharpe & Dohme of Canada.

### III. INTERPRETATION OF MULTIPLE-RESONANCE SPECTRA

The ion-cyclotron multiple-resonance technique involves the application of a pulsed irradiating field at the cyclotron frequency of a reactant ion.<sup>7,8</sup> The pulsed irradiating field varies the velocity of the reactant ion. If the reaction rate varies with ion energy, the concentration of product ions in the resonance region of the cell will also vary with the amplitude of the irradiating field. This time variation in the product-ion concentration can be observed by using a marginal oscillator detector referenced to the pulsing frequency. The multiple-resonance spectra thus not only serve to identify ion-molecule reactions, but also to characterize their energy dependence.

Let  $P(t)$  be the primary ion current and  $P(0)$  the rate of ion formation at the electron beam in the source region. If  $S(t)$  is the secondary ion current produced by a bimolecular ion-molecule reaction from  $P(t)$ , then

$$dP/dt = -nkP(t), \quad (8)$$

and

$$dS/dt = nkP(t), \quad (9)$$

where  $k$  is the biomolecular rate constant and  $n$  is the number density of the neutral reactant molecules. The solution of Eqs. (8) and (9) gives

$$P(t) = P(0) \exp(-nkt) \quad (10)$$

and

$$S(t) = P(0)[1 - \exp(-nkt)]. \quad (11)$$

The observed single-resonance intensities of the primary ( $I_p$ ) and secondary ( $I_s$ ) ions are obtained by integrating  $P(t)$  and  $S(t)$  over the resonance region of the cell:

$$I_p = \frac{C_p}{m_p} \int_{\tau}^{\tau'} P(t) dt = [C_p P(0) / m_p nk] [\exp(-nkr) - \exp(-nk\tau')], \quad (12)$$

$$I_s = [C_s P(0) / m_s nk] \{ nk(\tau' - \tau) - [\exp(-nk\tau) - \exp(-nk\tau')] \}, \quad (13)$$

where  $\tau$  and  $\tau'$  are, respectively, the times at which the ion enters and leaves the cell and  $m_p$  and  $m_s$  are the masses of the primary and secondary ions. The factors  $C_p/m_p = e^2 E_1^2 / 4m_p \xi_p$  and  $C_s/m_s = e^2 E_1^2 / 4m_s \xi_s$  arise from the expression for the power absorption of ions<sup>11</sup> given

in the case of the primary ions by

$$A(\omega_1) = (n_p^+ e^2 E_1^2 / 4m_p) \{ \xi_p / [(\omega_1 - \omega_p)^2 + \xi_p^2] \}, \quad (14)$$

where  $n_p^+$  is the total number of primary ions observed,  $\omega_1$  and  $E_1$  are the observing oscillator frequency and electric-field strength,  $\xi_p$  is the collision frequency for momentum transfer, and  $\omega_p$  and  $m_p$  are the cyclotron frequency and mass of the observed ion (related by  $\omega_p = eH/m_p c$ ).

Equation (14) also gives the power absorbed by ions of mass  $m_p$  from the irradiating field used in pulsed double resonance with the substitution of the frequency  $\omega_2$  and the electric-field strength  $E_2$  of the irradiating oscillator. In the presence of the irradiating field, the average ion energy is related to the power absorption by the expression<sup>11</sup>

$$E_{ion} = \frac{3}{2} kT + [(m_p + M) A(\omega_2) / 2\xi_p m_p n_p^+], \quad (15)$$

where  $M$  is the mass of the neutral species relaxing the ion momentum. Combining Eqs. (14) and (15) gives, at resonance ( $\omega_2 = \omega_p$ ),

$$E_{ion} = \frac{3}{2} kT + [e^2 E_2^2 (m_p + M) / 8\xi_p^2 m_p^2]. \quad (16)$$

The first term on the right of Eq. (16) represents the thermal energy of the ion and the second term is the energy due to the irradiation.

The pulsed-double-resonance technique is usually applied with low-irradiating field strengths. Under these conditions it is convenient to expand  $k$  about thermal ion energies as

$$k = k^0 + (dk/dE_{ion})^0 E_{ion} - \frac{3}{2} kT \equiv k^0(1 + \alpha), \quad (17)$$

where the superscript zero indicates that the quantity is to be evaluated at thermal energy. Using Eq. (17) and taking into account that the irradiating field is applied only in the resonance region of the cell, the secondary ion current in the presence of the irradiating field,  $S'(t)$ , and the secondary ion absorption signal intensity in the presence of the irradiating field  $I_s'$  are obtained as

$$S'(t) = P(0) \{ 1 - \exp(-nk^0\tau) \times \exp[-nk^0(1 + \alpha)(t - \tau)] \}, \quad (18a)$$

$$I_s' = [C_s P(0) / m_s] \{ (\tau' - \tau) - [\exp(\alpha nk^0\tau) / (1 + \alpha) nk^0] \times \{ \exp[-nk^0(1 + \alpha)\tau] - \exp[-nk^0(1 + \alpha)\tau'] \} \}. \quad (18b)$$

Since the pulsed-double-resonance spectrum directly displays the difference between  $I_s$  and  $I_s'$ , it will be given to first order in  $\alpha$  by

$$\Delta I_s = I_s' - I_s = [\alpha C_s P(0) / m_s nk^0] [\exp(-nk^0\tau) - (1 + nk^0\tau' - nk^0\tau) \exp(-nk^0\tau')]. \quad (19)$$

<sup>11</sup> J. L. Beauchamp, J. Chem. Phys. **42**, 1231 (1967).

TABLE II. Proton affinities and heats of formation.<sup>a</sup>

Species (M)	$\Delta H_f(M)$ kcal/mole	$\Delta H_f(M^+)$ kcal/mole	$\Delta H_f(MH^+)$ kcal/mole	Proton affinity PA (M) kcal/mole	Hydrogen affinity HA (M <sup>+</sup> ) kcal/mole
Methane	-17.9	281	229±3	118±3	104±3
Acetylene	54.2	317	281±2	138±2	88±2
Ethylene	12.5	255	220±4	158±4	87±4
Formaldehyde	-27.7	223	172±3	165±3	103±3
Propylene	4.6	229	191±2	179±2	90±2
Isobutylene	-4.0	209	170±4	192±4	92±4
Water	-57.8	232	143±4 <sup>b</sup>	164±4 <sup>b</sup>	141±4 <sup>b</sup>
Hydrogen sulfide	-4.8	236	182±2 <sup>b</sup>	178±2 <sup>b</sup>	106±2 <sup>b</sup>

<sup>a</sup> Heats of formation are for the gas phase at 298°K.<sup>b</sup> Determined in this study.

TABLE III. Reactions observed.

Gas mixture	Reactions observed	$(dk/dE_{ion})^0$	Thermodynamic inferences <sup>a</sup>
H <sub>2</sub> S	H <sub>2</sub> S <sup>+</sup> +H <sub>2</sub> S→H <sub>3</sub> S <sup>+</sup> +HS	-	$\Delta H_f(H_3S^+) \leq 198$
	HS <sup>+</sup> +H <sub>2</sub> S→H <sub>3</sub> S <sup>+</sup> +S	-	$\Delta H_f(H_3S^+) \leq 206^b$
H <sub>2</sub> S+CD <sub>4</sub>	H <sub>2</sub> S <sup>+</sup> +CD <sub>4</sub> →H <sub>2</sub> DS <sup>+</sup> +CD <sub>3</sub> <sup>c</sup>	-	$\Delta H_f(H_3S^+) \leq 184$
H <sub>2</sub> S+C <sub>2</sub> H <sub>4</sub>	H <sub>2</sub> S <sup>+</sup> +C <sub>2</sub> H <sub>4</sub> →H <sub>2</sub> S+C <sub>2</sub> H <sub>4</sub> <sup>+</sup>	+	$\Delta H = +1$
	C <sub>2</sub> H <sub>4</sub> <sup>+</sup> +H <sub>2</sub> S→H <sub>3</sub> S <sup>+</sup> +C <sub>2</sub> H <sub>4</sub>	+	$\Delta H = -1$
	C <sub>2</sub> H <sub>3</sub> <sup>+</sup> +C <sub>2</sub> H <sub>4</sub> →C <sub>2</sub> H <sub>2</sub> +C <sub>2</sub> H <sub>5</sub> <sup>+</sup>	-	$\Delta H = -20$
	C <sub>2</sub> H <sub>3</sub> <sup>+</sup> +H <sub>2</sub> S→H <sub>3</sub> S <sup>+</sup> +C <sub>2</sub> H <sub>2</sub>	-	$\Delta H_f(H_3S^+) \leq 222$
	C <sub>2</sub> H <sub>5</sub> <sup>+</sup> +H <sub>2</sub> S→H <sub>3</sub> S <sup>+</sup> +C <sub>2</sub> H <sub>4</sub> <sup>d</sup>	-	$\Delta H_f(H_3S^+) \leq 202$
	HS <sup>+</sup> +C <sub>2</sub> H <sub>4</sub> →HS+C <sub>2</sub> H <sub>4</sub> <sup>+</sup>	+	$\Delta H \cong +2^b$
H <sub>2</sub> S+C <sub>3</sub> H <sub>6</sub>	H <sub>2</sub> S <sup>+</sup> +C <sub>3</sub> H <sub>6</sub> →H <sub>2</sub> S+C <sub>3</sub> H <sub>6</sub> <sup>+</sup>	+	$\Delta H = -15$
	H <sub>2</sub> S <sup>+</sup> +C <sub>3</sub> H <sub>6</sub> →HS·+C <sub>3</sub> H <sub>7</sub> <sup>+</sup>	-	$\Delta H \leq 0$
	H <sub>3</sub> S <sup>+</sup> +C <sub>3</sub> H <sub>6</sub> →H <sub>2</sub> S+C <sub>3</sub> H <sub>7</sub> <sup>+</sup>	-	$\Delta H_f(H_3S^+) \geq 181$
	C <sub>3</sub> H <sub>7</sub> <sup>+</sup> +H <sub>2</sub> S→H <sub>3</sub> S <sup>+</sup> +C <sub>3</sub> H <sub>6</sub>	+	
	C <sub>3</sub> H <sub>6</sub> <sup>+</sup> +H <sub>2</sub> S→H <sub>3</sub> S <sup>+</sup> +C <sub>3</sub> H <sub>5</sub>	+	$\Delta H = +6^e$
H <sub>2</sub> S+H <sub>2</sub> O	H <sub>2</sub> O <sup>+</sup> +H <sub>2</sub> S→H <sub>2</sub> O+H <sub>3</sub> S <sup>+</sup>	+	$\Delta H = -49$
	H <sub>2</sub> O <sup>+</sup> +H <sub>2</sub> S→H <sub>2</sub> O+H <sub>3</sub> S <sup>+</sup> <sup>d</sup>	-	PA(H <sub>2</sub> S) ≥ PA(H <sub>2</sub> O)
	H <sub>2</sub> S <sup>+</sup> +H <sub>2</sub> O→HS+H <sub>3</sub> O <sup>+</sup> <sup>e</sup>	-	$\Delta H_f(H_3O^+) \leq 145$
H <sub>2</sub> O	H <sub>2</sub> O <sup>+</sup> +H <sub>2</sub> O→H <sub>3</sub> O <sup>+</sup> +OH	-	$\Delta H_f(H_3O^+) \leq 165$
H <sub>2</sub> O+C <sub>2</sub> H <sub>4</sub>	C <sub>2</sub> H <sub>2</sub> <sup>+</sup> +H <sub>2</sub> O→H <sub>3</sub> O <sup>+</sup> +C <sub>2</sub> H <sub>2</sub>	-	$\Delta H_f(H_3O^+) \leq 169$
	C <sub>2</sub> H <sub>5</sub> <sup>+</sup> +H <sub>2</sub> O→H <sub>3</sub> O <sup>+</sup> +C <sub>2</sub> H <sub>4</sub>	-	PA(H <sub>2</sub> O) ≅ PA(C <sub>2</sub> H <sub>4</sub> )
	H <sub>3</sub> O <sup>+</sup> +C <sub>2</sub> H <sub>4</sub> →H <sub>2</sub> O+C <sub>2</sub> H <sub>5</sub> <sup>+</sup>	-	$\Delta H_f(H_3O^+) \cong 149$
	H <sub>2</sub> O <sup>+</sup> +C <sub>2</sub> H <sub>4</sub> →H <sub>2</sub> O+C <sub>2</sub> H <sub>4</sub> <sup>+</sup>	+	$\Delta H = -48$
	C <sub>2</sub> H <sub>2</sub> <sup>+</sup> +C <sub>2</sub> H <sub>4</sub> →C <sub>2</sub> H <sub>2</sub> +C <sub>2</sub> H <sub>4</sub> <sup>+</sup>	+	$\Delta H = -21$
C <sub>2</sub> H <sub>4</sub> +C <sub>2</sub> H <sub>5</sub> OH	H <sub>3</sub> O <sup>+</sup> +C <sub>2</sub> H <sub>5</sub> OH→C <sub>2</sub> H <sub>5</sub> OH <sub>2</sub> <sup>+</sup> +H <sub>2</sub> O	-	PA(C <sub>2</sub> H <sub>5</sub> OH) ≥ PA(H <sub>2</sub> O)
	C <sub>2</sub> H <sub>3</sub> <sup>+</sup> +C <sub>2</sub> H <sub>4</sub> →C <sub>2</sub> H <sub>5</sub> <sup>+</sup> +C <sub>2</sub> H <sub>2</sub>	-	$\Delta H = -20$
CH <sub>2</sub> O+H <sub>2</sub> O	CHO <sup>+</sup> +H <sub>2</sub> O→H <sub>3</sub> O <sup>+</sup> +CO	-	PA(H <sub>2</sub> O) ≥ PA(CO)
	H <sub>3</sub> O <sup>+</sup> +CH <sub>2</sub> O→CH <sub>2</sub> OH <sup>+</sup> +H <sub>2</sub> O	-	$\Delta H_f(H_3O^+) \geq 142$ kcal
	H <sub>2</sub> O <sup>+</sup> +CH <sub>2</sub> O→CH <sub>2</sub> OH <sup>+</sup> +OH	-	$\Delta H = -23$
	CHO <sup>+</sup> +CH <sub>2</sub> O→CH <sub>2</sub> OH <sup>+</sup> +CO	-	$\Delta H = -41^f$
H <sub>2</sub> O+C <sub>2</sub> H <sub>5</sub> Br	C <sub>2</sub> H <sub>5</sub> <sup>+</sup> +H <sub>2</sub> O→H <sub>3</sub> O <sup>+</sup> +C <sub>2</sub> H <sub>4</sub>	-	$\Delta H_f(H_3O^+) \geq 149$

<sup>a</sup> All quantities are given in kcal/mole.<sup>b</sup> Assuming  $\Delta H_f(HS^+) = 276$  kcal/mole [from T. F. Palmer and F. P. Lossing, J. Am. Chem. Soc. **84**, 4661 (1962)].<sup>c</sup> Reaction observed below the appearance potential of the neutral reactant.<sup>d</sup> Reverse reaction was examined but not detected.<sup>e</sup> Calculated assuming  $\Delta H_f(H_3S^+) = 182$  kcal/mole.<sup>f</sup> Assuming  $\Delta H_f(HCO^+) \cong 215 \pm 10$  kcal/mole [(from R. I. Reed and J. C. D. Brand, Trans. Faraday Soc. **54**, 478 (1958))].

Using Eqs. (17) and (16) it is possible to express  $\alpha$  in terms of  $A(\omega_2)$  such that the expression for the pulsed-double-resonance signal becomes

$$\Delta I_s = \frac{(dk/dE_{ion})^0 A(\omega_2) (M + m_p) C_s P(0)}{2m_p m_s \xi_p (nk^0)^2} \times [\exp(-nk^0\tau) - (1 + nk^0\tau' - nk^0\tau) \exp(-nk^0\tau')]. \quad (20)$$

Thus the pulsed-double-resonance spectrum of the secondary ion obtained by sweeping  $\omega_2$  will possess the same resonant behavior (including resolution) as the single-resonance spectrum of the parent ion and will be directly proportional to  $(dk/dE_{ion})^0$  in the limit of vanishing irradiating field strength. The sign and magnitude of the pulsed-double-resonance spectrum clearly provide useful information concerning the variation of  $k$  with ion energy.

#### IV. RESULTS

Limits on the proton affinity of a species (M) can be determined by observing reactions of the type

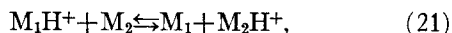

in which the proton affinity of either of the neutral reactant or product is known. The simple hydrocarbon species listed in Table II are particularly convenient in this respect. The proton and hydrogen affinities are calculated using Eqs. (3) and (4) and appropriate thermochemical data. Neutral heats of formation are from standard sources.<sup>12</sup> The heats of formation of the protonated species have been taken from Field and Franklin<sup>13</sup> and revised slightly in accordance with recent electron impact<sup>14</sup> and photoionization<sup>15</sup> data as

TABLE IV. Relationship between the pulsed-double-resonance signal,  $\Delta I_s$ , and  $\Delta H$  of the ion-molecule reaction.

If $\Delta I_s$ is	+	-
Then $\Delta H$ is	+ or -	-
If $\Delta H$ is	+	-
Then $\Delta I_s$ is	+	+ or -

well as the recent tabulation of radical heats of formation by Kerr.<sup>16</sup>  $\Delta H_f(\text{CH}_5^+)$  has been determined by Munson and Field<sup>17</sup> in their chemical ionization studies.

Table III summarizes the ion-molecule reactions examined in this study. Included in Table III is the sign of  $(dk/dE_{ion})^0$  for each reaction. In accordance with Eq. (20) this is simply the sign of the pulsed-double-resonance contribution from the reactant ion to the observed product. Our general observations in this and other studies are that  $(dk/dE_{ion})^0$  is (1) negative for exothermic proton-transfer reactions of the type indicated by Reaction (21) and (2) positive for exothermic charge-transfer reactions. All of the reactions in Table III for which  $\Delta H$  is known are consistent with these observations. It should be noted that a reaction which gives a negative pulsed-double-resonance signal must be occurring at thermal energies and *must* therefore be exothermic or thermoneutral. A reaction which gives a positive pulsed-double-resonance signal may be either endothermic or exothermic, but an endothermic reaction *must* give a positive pulsed-double-resonance signal near threshold. These relationships are summarized in Table IV.

The reactions which best limit the proton affinity of hydrogen sulfide are

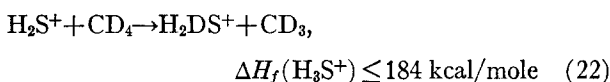

and

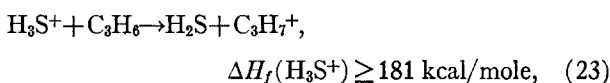

which give  $\Delta H_f(\text{H}_3\text{S}^+) = 182 \pm 2$  kcal/mole. This corresponds to  $\text{PA}(\text{H}_2\text{S}) = 178 \pm 2$  kcal/mole and  $\text{HA}(\text{H}_2\text{S}^+) = 106 \pm 2$  kcal/mole. Reaction (22) has been previously reported by Field and Lampe.<sup>18</sup> The single-resonance spectrum of an approximately 1:1 mixture of hydrogen sulfide and propylene at  $8 \times 10^{-5}$  torr and 14-eV electron energy is presented in Fig. 2(a). Prominent peaks are noted for  $\text{H}_3\text{S}^+$  ( $m/e=35$ ) and  $\text{C}_3\text{H}_7^+$  ( $m/e=43$ ) in addition to products of the reactions known to occur in propylene.<sup>19</sup> The pulsed-double-

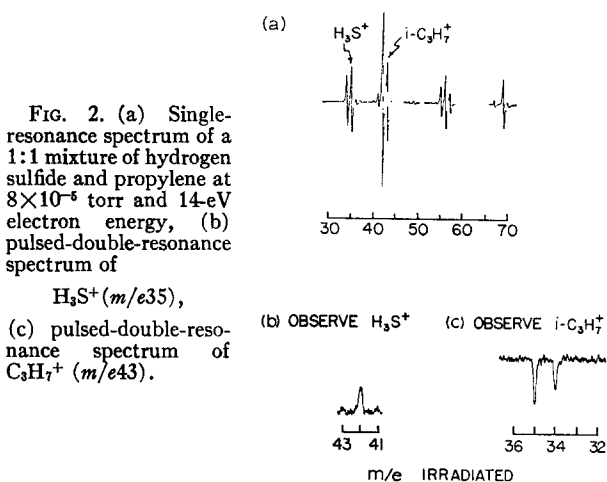

FIG. 2. (a) Single-resonance spectrum of a 1:1 mixture of hydrogen sulfide and propylene at  $8 \times 10^{-5}$  torr and 14-eV electron energy, (b) pulsed-double-resonance spectrum of

$\text{H}_3\text{S}^+$  ( $m/e 35$ ),

(c) pulsed-double-resonance spectrum of  $\text{C}_3\text{H}_7^+$  ( $m/e 43$ ).

<sup>12</sup> F. D. Rossini, K. S. Pitzer, R. L. Arnett, R. M. Braun, and G. C. Pimentel, API Research Project No. 44, Carnegie Press, Pittsburgh, Pa., 1953.

<sup>13</sup> F. H. Field and J. L. Franklin, *Electron Impact Phenomena and the Properties of Gaseous Ions* (Academic Press Inc., New York, 1957).

<sup>14</sup> C. E. Melton and W. H. Hamill, *J. Chem. Phys.* **41**, 3464 (1964).

<sup>15</sup> F. H. Elder, C. F. Giese, B. Sterner, and M. G. Inghram, *J. Chem. Phys.* **36**, 3292 (1962).

<sup>16</sup> J. A. Kerr, *Chem. Rev.* **66**, 465 (1966).

<sup>17</sup> M. S. B. Munson and F. H. Field, *J. Am. Chem. Soc.* **87**, 3294 (1965).

<sup>18</sup> F. H. Field and F. W. Lampe, *J. Am. Chem. Soc.* **80**, 5583 (1958).

<sup>19</sup> L. W. Sieck and J. H. Futtrell, *J. Chem. Phys.* **45**, 560 (1966).

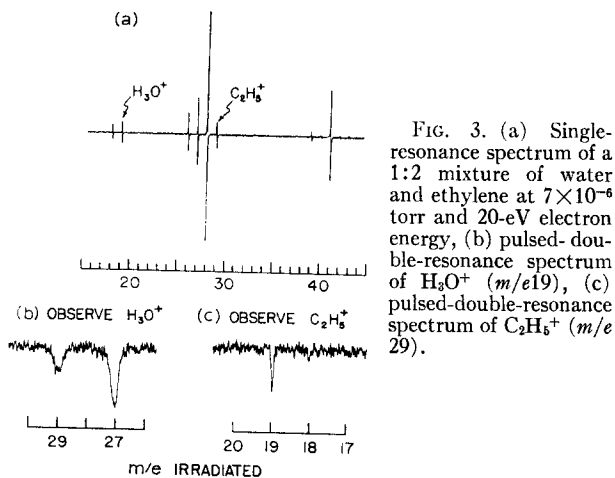
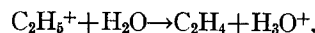

FIG. 3. (a) Single-resonance spectrum of a 1:2 mixture of water and ethylene at  $7 \times 10^{-6}$  torr and 20-eV electron energy, (b) pulsed-double-resonance spectrum of  $\text{H}_3\text{O}^+$  ( $m/e=19$ ), (c) pulsed-double-resonance spectrum of  $\text{C}_2\text{H}_5^+$  ( $m/e=29$ ).

resonance spectrum of  $\text{H}_3\text{S}^+$  [Fig. 2(b)] under these conditions exhibits contributions from  $m/e=41$ , 42, and 43, all with positive  $(dk/dE_{\text{ion}})^0$ . At higher irradiation power only the contributions from  $m/e=42$  ( $\text{C}_3\text{H}_6^+$ ) and  $m/e=43$  ( $\text{C}_3\text{H}_7^+$ ) are significant. The pulsed-double-resonance spectrum of  $\text{C}_3\text{H}_7^+$  [Fig. 2(c)] exhibits contributions from  $m/e=34$  ( $\text{H}_2\text{S}^+$ ) and  $m/e=35$  ( $\text{H}_3\text{S}^+$ ), both with negative  $(dk/dE_{\text{ion}})^0$ . These results imply the occurrence of Reaction (23) at thermal-ion energy.

Several reactions suggest upper and lower limits for the proton affinity of water. The reactions



$$\Delta H_f(\text{H}_3\text{O}^+) \leq 149 \text{ kcal/mole} \quad (24)$$

and

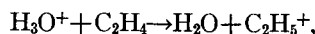

$$\Delta H_f(\text{H}_3\text{O}^+) \geq 149 \text{ kcal/mole} \quad (25)$$

were both observed with a negative  $(dk/dE_{\text{ion}})^0$ . The single-resonance spectrum of a 1:2 mixture of water and ethylene at  $7 \times 10^{-6}$  torr and 20-eV electron energy

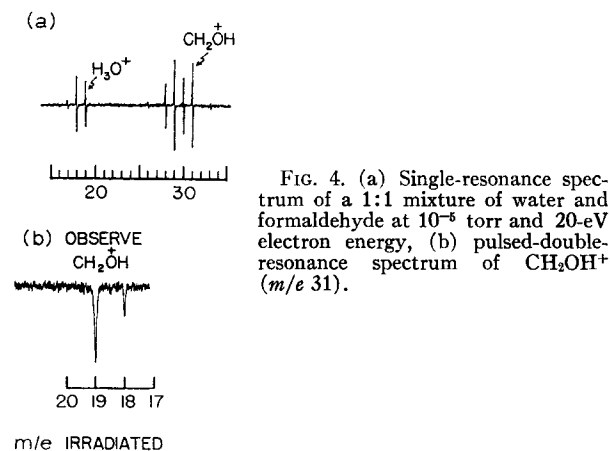

FIG. 4. (a) Single-resonance spectrum of a 1:1 mixture of water and formaldehyde at  $10^{-6}$  torr and 20-eV electron energy, (b) pulsed-double-resonance spectrum of  $\text{CH}_2\text{OH}^+$  ( $m/e=31$ ).

[Fig. 3(a)] exhibits reaction products corresponding to  $\text{H}_3\text{O}^+$ ,  $\text{C}_2\text{H}_5^+$ , and  $\text{C}_3\text{H}_5^+$ , the last ion being a product of the reaction of  $\text{C}_2\text{H}_4^+$  with  $\text{C}_2\text{H}_4$ .  $\text{C}_2\text{H}_5^+$  is formed primarily by proton transfer from  $\text{C}_2\text{H}_3^+$ . The pulsed-double-resonance spectrum of  $\text{H}_3\text{O}^+$  [Fig. 3(b)] exhibits contributions from  $m/e=27$  ( $\text{C}_2\text{H}_3^+$ ) and  $m/e=29$  ( $\text{C}_2\text{H}_5^+$ ), both with negative  $(dk/dE_{\text{ion}})^0$ . The pulsed-double-resonance spectrum of  $\text{C}_2\text{H}_5^+$  [Fig. 3(c)] shows a contribution from  $m/e=19$  ( $\text{H}_3\text{O}^+$ ), again with a negative  $(dk/dE_{\text{ion}})^0$ . Reaction (24) was examined in a mixture of water and bromoethane with the same results. A small amount of  $\text{H}_3\text{O}^+$  is formed by electron impact in ethanol. In a 2:1 mixture of ethylene with ethanol no contribution from  $\text{H}_3\text{O}^+$  to  $\text{C}_2\text{H}_5^+$  could be observed. Under the same conditions proton transfer from  $\text{H}_3\text{O}^+$  to  $\text{C}_2\text{H}_5\text{OH}_2^+$  was easily detected. These results suggest that  $\text{PA}(\text{H}_2\text{O}) \lesssim \text{PA}(\text{C}_2\text{H}_4) = 158$  kcal/mole and indicate the possibility of a process occurring in a mixture of ethylene and water which produces

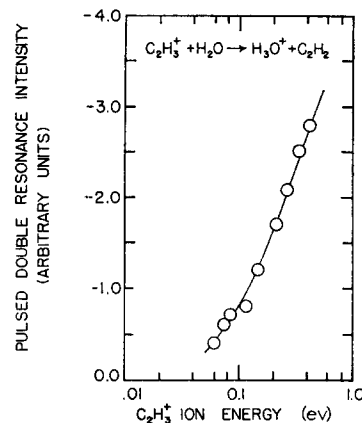
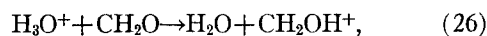

FIG. 5. Variation of pulsed-double-resonance contribution from  $\text{C}_2\text{H}_5^+$  to  $\text{H}_3\text{O}^+$  with ion-translational energy.

$\text{H}_3\text{O}^+$  with sufficient internal excitation for Reaction (25) to be exothermic. Since Reaction (6) gives a lower limit for  $\text{PA}(\text{H}_2\text{O})$  of  $162 \pm 2$  kcal/mole it was re-examined. With electron energies near the ionization threshold of  $\text{H}_2\text{S}$  and below the ionization potential of  $\text{H}_2\text{O}$  the single-resonance spectrum of a mixture of water and hydrogen sulfide shows the presence of  $\text{H}_3\text{O}^+$ . Double-resonance experiments indicate that  $\text{H}_3\text{O}^+$  in this mixture is produced by  $\text{H}_2\text{S}^+$  with a negative value of  $(dk/dE_{\text{ion}})^0$ . The occurrence of Reaction (6) at thermal energies is thus confirmed. As pointed out by Kerr,<sup>16</sup> the heat of formation of the  $\text{HS}\cdot$  radical is not well known. Kerr's "best value" of  $\Delta H_f(\text{HS}\cdot) = 33 \pm 3$  kcal/mole has been used. An upper limit for  $\text{PA}(\text{H}_2\text{O})$  of  $165 \pm 3$  kcal/mole is established by the reaction [observed with negative  $(dk/dE_{\text{ion}})^0$ ]



for which no reverse was detected. Formaldehyde was prepared by thermal decomposition of paraformaldehyde.

hyde. Figure 4(a) shows the single-resonance spectrum of an approximately 1:1 mixture of water and formaldehyde. The pulsed-double-resonance contributions from H<sub>2</sub>O<sup>+</sup> and H<sub>3</sub>O<sup>+</sup> to CH<sub>2</sub>OH<sup>+</sup> are shown in Fig. 4(b).

The value  $\Delta H_f(\text{H}_3\text{O}^+) = 143 \pm 4$  kcal/mole satisfies the limits established by the various reactions which involve H<sub>3</sub>O<sup>+</sup>. This corresponds to proton and hydrogen affinities of  $164 \pm 4$  kcal/mole and  $141 \pm 4$  kcal/mole, respectively.

The possibility that some of the reactant ions in these experiments may possess vibrational or electronic excitation introduces a source of uncertainty in these results. To minimize the production of ions excited by electron impact, all of the experiments were conducted with electron energies as low as practical. In particular, Reactions (6) and (22) which place upper limits on  $\Delta H_f(\text{H}_3\text{O}^+)$  and  $\Delta H_f(\text{H}_3\text{S}^+)$  were studied within 1 eV of threshold. Secondary ions which are products of highly exothermic reactions may possess appreciable internal and translational excitation. The H<sub>3</sub>S<sup>+</sup> ion in Reaction (23) and the H<sub>3</sub>O<sup>+</sup> ion in Reaction (26) could both be in excited states. However, the reverse of Reaction (26) is not detected and the reverse of Reaction (23) occurs weakly and with positive  $(dk/dE_{\text{ion}})^0$ . These facts suggest that Reactions (23) and (26) are exothermic for ground-state ions.

In order to demonstrate that the pulsed-double-resonance technique can identify ion-molecule reactions without excessive *translational* excitation of the reactant ion, the proton-transfer reaction

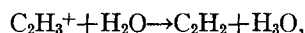

$$\Delta H \cong -26 \text{ kcal/mole} \quad (27)$$

has been examined. As indicated by Eqs. (14) and (20), the linewidth of the pulsed-double-resonance spectrum is given by twice the collision frequency for momentum transfer  $\xi_P$ . Determining  $\xi_P$  from the linewidth thus permits  $E_{\text{ion}}$ , the translational energy of C<sub>2</sub>H<sub>3</sub><sup>+</sup>, to be

calculated using Eq. (16). The results of this analysis for Reaction (27) are presented in Fig. 5. The pulsed double resonance-intensity extrapolates to zero at an ion energy of approximately 0.04 eV.

## V. DISCUSSION

Our value of  $182 \pm 2$  kcal/mole for  $\Delta H_f(\text{H}_3\text{S}^+)$  is 10–20 kcal/mole higher than that derived from electron-impact studies (Table I). It would thus appear that the identities of the neutral fragments formed when H<sub>3</sub>S<sup>+</sup> (a major rearrangement ion) is produced by electron impact from the species listed in Table I have not been well established. The value  $143 \pm 4$  kcal/mole for  $\Delta H_f(\text{H}_3\text{O}^+)$  appears to be fairly consistent with the value derived by Van Raalte and Harrison<sup>8</sup> (Table I). In each case the electron-impact value is about 10–15 kcal/mole greater than our value. It is well known that the production of rearrangement ions in mass spectra often requires activation energies in this range.<sup>20</sup> PA(H<sub>2</sub>O) =  $164 \pm 4$  kcal/mole is in good agreement with the value  $168 \pm 7$  kcal/mole determined by Sokolov *et al.*<sup>1</sup> from crystal-lattice energies.

Ion-cyclotron single- and multiple-resonance techniques provide a simple means for identifying ion-molecule reactions and examining certain aspects of their energetics even in complex mixtures. The simple methods by which the proton affinities of water and hydrogen sulfide were determined are directly applicable to the determination of any other unknown proton affinity or heat of formation.

## ACKNOWLEDGMENTS

The authors thank Professor J. D. Baldeschwieler for his encouragement and assistance in this study and are indebted to J. V. Garcia for his technical assistance. This research was supported by the National Science Foundation under grants GP-4924x and GP-6548.

<sup>20</sup> Reference 13, Table 9.