

**Equilibrium, Equilibration, Information and Multiple Markets:  
From Basic Science to Institutional Design**

Charles R. Plott  
California Institute of Technology

Prepared for the Nobel Symposium on  
Experimental and Behavioral Economics, 2001

**Equilibrium, Equilibration, Information and Multiple Markets:  
From Basic Science to Institutional Design**

Symposium on Behavioral and Experimental Economics, December 4-10,2001

Charles R. Plott  
California Institute of Technology  
November 2001

Prices exhibit subtle coordination features among multiple markets, reflecting opportunity costs and fostering specialization throughout the economy. Furthermore, it is widely believed that prices can adjust rapidly, and possibly almost immediately while carrying information about worldly events from insiders to non-insiders who can use it. By receiving the information contained in prices the otherwise uninformed can adjust to those events. Not only do prices appropriately reflect opportunity cost within properly supportive institutions, they carry all available, relevant information known throughout the economy.

The theory that leads to such a broad interpretation of market processes is based on technical principles and an appropriate institutional setting. The economy can be described by a large set of equations, roughly on the order of the number of individuals and firms times the number of commodities that exist to be produced and allocated. Equilibrium follows as a solution to the system of equations, a delicate pattern of zeros that balance demand and supply across the economy. In addition to finding the solutions to this system of equations the markets are acting like a statistician, gathering information scattered within the system, aggregating it and publishing it so that the knowledge of insiders is available for all to use in making economic plans. Basically, the markets are finding the zeros of a system of equations that no one knows and in the process are collecting information that is disbursed across the system, like a giant statistical vacuum cleaner, organizing it and publishing it for all to use.

Theories are rather vague about the types of institutions that might be helpful or harmful but if market institutions of any form and in any context can actually perform such tasks, it is an amazing and potentially valuable feature of human social interaction. Not only could (perhaps selective) competitive processes be interpreted as efficiently allocating resources; they can also be understood as promoting an efficient use of information. Furthermore, if such powers can be harnessed, then it might be possible to create new forms of competitive processes, unlike those that have evolved naturally, and use them to solve problems that were thought to be beyond solution.

Rather natural questions have motivated a broad spectrum of basic research. These questions are used to organize the paper. First, can any form of markets do it? Is the capacity to find the zeros and collect the information simply beyond the abilities of humans and decentralized human organization? Secondly, if markets can do it, how do they do it? What principles are in operation? Third, how can we find an answer to the

first two questions? Field data are staggeringly complex with many parameters associated with any data set and a near impossibility of determining if some exact set of equations were solved. It might be even harder to measure the initial pattern of information that existed in the system to be collected. In view of this complexity how can the answer to the first questions be determined? Of course, the answer to the third question will be to use laboratory experiments and part of this review is intended to illustrate how that can be done.

The answer to the third question motivates a fourth question: of what use are any answers produced by laboratory experimental methods? While laboratory markets may be real markets, they are, nevertheless, very simple. Applications of general interest are in complex, naturally occurring markets. Of what good are the lessons from experiments if applications in the complex field environments are the sources of interest?

The approach to answering this fourth question is similar to the approach used by all experimentalists, if not all basic scientists in all branches of science – by example. The strategy is to illustrate how basic science, motivated by the first questions has had the unintended consequence of producing results that were useful for application. As it turns out, the example used here is only one of many examples of such success.

The answer to this fourth question heavily influenced the organization of this paper. The final section of the paper discusses an example of what will be called an “Information Aggregation Mechanism” that was designed and implemented as a tool to be used only for the purpose of collecting and aggregating information that was otherwise distributed as intuition and opinions among a group of people. The tool itself and the ability to implement it are the results of a long history of basic, laboratory experimental research. The paper is organized to illustrate the nature of answers to the first two questions posed above but the answers are constrained to research that directly or indirectly proved to be important for the application. Rather than exploring the enormous range of experiments that each of the first two questions have motivated, the paper will be constrained to research that is closely related to the path that leads to the application presented in the final section.

The paper is outlined as follows. The first two sections are intended as introductory material for those unacquainted with laboratory experimental methods and/or the background models that are used to interpret results. Section one, “Institutions and Experimental Procedures”, is an introduction to the special trading mechanism that is used in the markets studied. An enormous range of market architectures has been studied but one in particular has emerged as the most efficient and for that reason it is the one that was used in the application. Section two, “A Brief Outline of the Classical Market Model”, introduces two important classes of models. The first is that of general equilibrium, the set of equations that the model suggests that the system solves and the second class contains specific models of price adjustment, which will be useful as tools for interpreting the data produced by markets. The intuition about the nature of economics provided by these models is fundamental. The third section, “Can Markets Find the Zeros?”, reviews two examples. As it turns out there are many demonstrations

of the ability of markets to solve the system of equations of the general equilibrium model. The examples chosen for the section demonstrate the robustness of that ability and lead to an understanding of possible limitations. The first example is a one commodity economy, which is reviewed simply to illustrate the nature of an experiment, the data produced in an experiment and how markets behave. It is included for those readers who are not steeped in the experimental economics literature. The second example is a three commodity case that will be used extensively to explore the price discovery process. Section four, "How Do Markets Do It? Principles of Market Adjustment", covers the major features of what is known about market adjustments in the light of the data produced by experiments. The classical models of dynamics are extremely useful and appear to hold secrets of the principles of price discovery. However, as it turns out, the classical theories of price adjustment are incomplete and that incompleteness suggests that any application should proceed with care. Section five, "Can Markets Collect and Aggregate Information?", turns to a discussion of information collection and the related issue of rational expectations. Experiments demonstrate that markets organized along the lines of those discussed in the first sections have the capacity to perform the task of information aggregation but the information collection process itself remains a mystery.

Section six, "Are The Lessons From Simple Cases Useful?", contains a discussion of an application. Many examples of laboratory experimental economics applications exist but this one is of special interest because it would not have been conceived and it certainly would not have been implemented had it not been for laboratory experiments.

## **Section 1. Economic and Institutional Environments**

For those unfamiliar with laboratory experimental methods in economics a brief orientation might be useful. Experimental methods in economics and in political science reflect a broad feature of models and theory. Many economics models if not all models, fall within what might be called a "fundamental equation" of economics and political science (Plott, 1979). The "equation" says that principles are typically based on interactions of four different classes of parameters. These classes of parameters consist of a commodity space, preferences over that commodity space, a subset of the commodity space called a feasible set of outcomes and institutions. The overriding principle that completes the model is called an equilibrium or solution concept, depending on the type of model employed.

By controlling such variables experimentalists are able to explore a wide variety of processes. The hard parts from the point of view of experimental control are the preferences and the institutions. The commodity space can be any abstract set and certainly the concept of a feasible set is not difficult to imagine. Equilibrium and solution concepts are part of theory used to predict the experimental outcomes and are not under the control of the experimenter. The idea is to control the preferences and institutions and ask about the extent to which the predictions of the solution concept or equilibrium concept are accurate and to compare the relative accuracy of different concepts.

The objective is to study the accuracy and relative inaccuracies of models. The process that can be created for study are simple but they are nevertheless real processes in the sense that real people follow real incentives in making real decisions. The simplicity of the processes should not be confused with the reality from the point of view of models. General models such as those typically applied to complex field settings should be expected to work in the simple and special cases. The experiments are designed to explore that possibility.

### 1.1 Induced Preferences

Key variables are obviously preferences. Given a commodity space, say  $X$ , preferences are induced by assigning a function  $U^i(x)$  to individual  $i$  that maps the outcomes of the process to dollars taken home by individual  $i$  who has a quantity  $x$ . Notice two facts. First if the individual prefers more money to less and if there are no side payments or other phenomena that might influence an individual's attitude toward  $X$ , then the function  $U^i(x)$  induces preferences for  $X$  through the classical theory of derived demand. The variables in  $X$  become valued as a means to an end. Second, there are no special bounds on the form of  $U^i(x)$ . In particular there is no need for the quasi-linear preferences characteristic of early economics experiments.<sup>1</sup> Third, there are no particular constraints on the dimensions of  $X$ . Thus, the system created for experimental study could involve private goods, public goods or combinations of private and public goods. General equilibrium systems can be created without the need for linearity or the absence of income effects implicit in the use of quasi-linearity.

In some cases the utility function can depend upon a state variable,  $\theta$ . Typically the probability of  $\theta$  is public information. For the experiments reported in the first four sections of the paper, underlying random variables are not important from the point of view of the structure of the environment. Special discussions will cover cases introduced later, in which information and randomness are important.

### 1.2 Time and the Economic Environment

As will become increasingly clear the notion of time plays an important role in the experiments that will be reported here. The economic environment proceeds as a series of trading periods or trading days. It is similar to the flow of economic activity involving daily trades and economic activities by contrast to the static equilibrium models often found useful. For the most part, in the experiments reviewed here the environment will have punctuated periods of stationarity in which the parameters at the start of one day are exactly like those of the preceding. Each individual is aware of his/her own parameters but knows nothing about the preferences or endowments of others. Changes of

---

<sup>1</sup> Smith (1976) formalized the concept of induced preferences. Generalization to cases in which quasi-linear preferences were not used was in the public economics context (Fiorina and Plott, 1978) and it is the non-quasi-linear form that tends to be used in the multi market settings. Without the quasi linear form the magnitude of incentives in terms of dollars need not be related at all to the prices that evolve in the markets.

parameters are not public information and are often hidden so any change in market conditions are not detectable by individuals whose parameters might have changed.

Many alternative structures have been studied. In some cases there is no structured end of a “trading day” and inventories carry forward from one day to the next. In other cases the environment incorporates assets in which the commodity might last many periods and the payoff at any instant might be related to payoffs in the past. In such environments speculative bubbles can occur and research has focused on the properties of instruments that might prevent their development.<sup>2</sup> For purposes to be made clear later, interest here is focused on institutions and on equilibration that is not interrupted by speculation. It is well known, and well illustrated below, that principles of equilibration work reliably under conditions of coordinated “trading days” or “trading periods”. Under such conditions bubbles and related phenomena are less likely to be observed. For this reason, the design of the “Information Aggregation Mechanism” reviewed in the last section incorporated the independent trading day environment.

### 1.3 Institutions: The Multiple Unit Double Auction

The markets reported here are all organized according to the multiple unit double auction process (MUDA) developed for implementation on the web through a program developed by the Caltech Laboratory for Experimental Economics and Political Science, called Marketscape. The importance of these technologies should not be minimized because they are the embodiment of special institutions. They are not simply “software programs”. They have a history of evolution and advancement in the light of experimental study.<sup>3</sup> These technologies and methodologies, together with the practical lessons from experiments made it possible to go (almost) directly from laboratory experiments to field applications such as the one discussed in the final section.

Subjects were located remotely at home or in offices and were logged into a real time and continuous market. Incentives were sent at the beginning of each period. Subjects who wanted to place orders could do so by choosing the market with a mouse click, filling in the price and quantity and with a click, sending the order to the market. An order that

---

<sup>2</sup> See Lei, Noussair and Plott (2001); Smith, Van Boening and Wellford (2000); Smith, Suchanek and Williams (1988); Van Boening, Williams and LaMaster (1993); Porter and Smith (1994).

<sup>3</sup> The history of this particular architecture reveals subtle aspects of trading institutions and very important advances in the technology of market architectures found in the experimental economics literature. The oral double auction in which agents could trade only one unit per period was first studied by Smith (1962). The generalization to the case in which agents could trade more than one unit per period was studied by Plott and Smith (1978), but still each transaction could involve only one unit. The implementation of an electronic version appeared with Williams (1980) who also introduced an electronic book when working closely with Vernon Smith. However, all trades could only involve only a single unit. Reflecting a need to study markets with large volume the double auction was generalized to the multiple unit double auction (Plott and Gray, 1990) called MUDA, in which each transaction could involve multiple units, which was implemented for local area networks of multiple markets by Johnson, Lee, and Plott (1989) and more recently for internet and web implementation as Caltech’s Marketscape programs. The Marketscape program is capable of supporting experiments with hundreds of markets and hundreds of traders located around the world. A methodology for managing experiments with a large number of remotely located subjects has also evolved.

“overlapped” the other side (an order to buy that was above the lowest sell order price or an order to sell that was below the highest buy order price) traded immediately up to the amount of the crossed order with any remaining treated as an unfilled order. Orders that did not overlap, the unfilled orders, were placed in a public order book. Clearance and settlement was immediate with the units transferred from the seller to the buyer and the money transferred from the buyer to the seller. All trades were public in the form of a list and in the form of a graph. Both were accessible through a mouse click. Unfilled orders could be cancelled by the agent placing the order. Any agent could speculate by buying and selling. The periods were of fixed length with a countdown clock indicating the amount of time left in a period. When a period was over each trader was informed of their financial position and given new incentives for the next period.

The multiple unit double auction was chosen for study because experiments have demonstrated that it has the capacity to support multiple markets with large volume and efficiently guide the process to the competitive equilibrium. By contrast, other double auctions, such as oral processes, or computerized processes that do not permit multiple unit trades, cannot carry the volume needed to support a large-scale market environment.

Many alternative architectures to the multiple unit double auction have been studied. Posted price processes, call markets such as a sealed bid and sealed offer process, ascending price auctions, etc. have all received attention in the literature. Among these, the computerized multiple unit double auction has proved to be most efficient. More is known about its behavior than the other architectures that are capable of supporting a multi-market economy. Many other institutions exist but none operates with the same efficiency, speed and accuracy when viewed as a price discovery process.<sup>4</sup>

The tatonnement mechanism is worthy of special mention. It comes immediately to mind because of its role helping theory avoid complexities due to possible trading at disequilibrium prices. The tatonnement mechanism has a fictional auctioneer announcing prices and having participants respond with the amounts that they are willing to trade at those prices. The auctioneer observes the responses and then if the equations describing the equilibrium are not satisfied a new set of prices is announced, perhaps determined by the application of some sort of numerical method. No trading takes place until the system has discovered the equilibrium. From the very beginning of the development of the general equilibrium model it was recognized that disequilibrium trades have a potential for changing the equilibrium predicted by the model. The knowledgeable reader will immediately recognize that the multiple unit double auction trading mechanism allows trading at disequilibrium prices.

Why not use the tatonnement mechanism in the application? As it turns out, experiments have demonstrated that the tatonnement mechanism is a very poor price discovery mechanism. The very thing that makes it attractive as a simplifying theoretical tool prevents it from being a practical tool. Because there is no commitment at the prices, agents tend to not respond with quantities that they are willing to live with. They also

---

<sup>4</sup> Some examples are call markets (Davis and Williams, 1997); unusual call markets (Cason and Plott, 1996); Sealed bid-Sealed offer (Smith, Williams, Bratton, and Vannoni, 1982).

seem to behave strategically in a manner that disrupts any convergence at all. In fact, for multiple commodity markets the tatonnement mechanism is a major failure. Many multiple market experiments have been conducted in which not one successful trade took place and the process never converged. (Plott, 1988) Thus, the basic experimental research suggests that it is not a good candidate for an expensive and visible field application.

## **Section 2. A Brief Outline of the Classical Market Model**

The theoretical focus will be on the classical models for which basic principles, that are widely applied in economics, appear in their simplest form. From the point of view of experiments the importance of these economic models cannot be overemphasized. They help with the design of the experiments. They help with the interpretation of the results. The models suggest the existence of subtle phenomena emerging from interactions and also suggest what might happen if the experimental design is changed.

Importantly, the models help with the development of intuition about what might be expected in the complex field situation in which the parameters will not be controlled. By necessity field applications involve a trust in theory beyond that justified by evidence. Applications rest on the hope that the theory is robust beyond anything that can be tested. Process architectures, when implemented in the field, involve many features other than those tested in laboratories. Furthermore, mechanisms created for application will operate in economic environments that are different from those tested and perhaps different from those that are known to theory. The theory provides a crude roadmap of a complex terrain, with many unmarked junctions, through which an application must navigate.

The section is divided into three parts. The first is the classical general equilibrium model. The next two are classical models of market dynamics. Interest in models of dynamics stems from a need to understand how a multiple market system in disequilibrium (as opposed to equilibrium) might respond under a variety of parameters. The specific focus is on stability and instability because parameters that might foster instability can give clear separation of competing ideas about the principles that underlie market adjustments.

### 2.1 General Equilibrium of an Exchange Economy

The essence of a complex economy is the interaction of individuals. It is the interaction and the resolution of gains from exchange and conflict as opposed to the individual acting in isolation that is fundamental from the point of view of the applications. The general equilibrium model has that interdependence at its heart.

Let  $\dot{z}^i = (z_1^i, \dots, z_n^i)$  be a vector of commodities consumed by individual  $i$ . Let  $U^i(\dot{z}^i)$  be a utility representation of the preferences of individual  $i$ . Let  $z^i$  be the initial endowments held by individual  $i$ . The classical competitive model is based on the following principles:



- i. In each of the  $n$  markets only one price exists  $p = (p_1, \dots, p_n)$ .
- ii. For each individual  $i$  an excess demand function  $E^i(p, z^i) = D^i(p, z^i) - z^i$  can be derived where  $z = D^i(p, z^i)$  is the solution to the problem  $\max U^i(z^i)$  subject to  $p(z^i - z^i) = 0$ .
- iii. Equilibrium is a price vector  $p$  such that  $E(p) = \sum_i E^i(p, z^i) = 0$

The principle (iii) is deceptively simple in statement. In fact, it embodies on the order of  $nm + n - 1$  equations where  $m$  is the number of individuals and  $n$  is the number of commodities.

The prices that solve (iii) and the allocations defined by (ii) are the predictions of the model. The sets of equations (ii) and (iii) are the equations that the economy is supposed to solve according to theory. If the experimenter knows the equations and if the prices and allocations are observable, then the theory itself is subject to test. The question posed by experiments is whether or not prices emerge from markets that are solutions to the many equations implicit in (ii) and (iii).

Economists have devoted decades toward attempting to understand if and how a multiple market system might “discover” the solutions to the appropriate set of equations. Classical ideas rest on the idea that markets will “adjust” or “grope” following a specific set of dynamic equations. Two such models have emerged as central to discussions in the literature. One has a long history starting with Walras and Hicks and was generalized by Samuelson. The second, which is essentially the inverse of the first, was developed by Marshall. Others exist in the literature but these two have received attention experimentally and are thus the focus here.

## 2.2 The Walras, Hicks, Samuelson Dynamics of Price Adjustment

Let  $p_j$  be the market price of commodity  $j$ . The classical model of adjustment initiated by Walras and extended by Hicks and Samuelson is summarized by the following principles:

- iv.  $dp_j/dt = \sum_k \lambda_{jk} E_k(p)$
- v. For  $k \neq j$ ,  $\lambda_{jk} = 0$ .
- vi. For  $k = j$ ,  $\lambda_{jk} > 0$ .

Samuelson’s hypothesis is that principles of market adjustments can be modeled by a system of differential equations with the characteristic that each market adjusts separately according to its own excess demand, not being influenced by the excess demand of other markets. Furthermore, market prices adjust positively in response to excess demand. If the quantity demanded at a price is greater than the quantity supplied at that price then the price goes up. Cross effects are limited to the effect of other prices on the demand for  $j$ .

## 2.3 The Marshallian Model of Price Adjustment

Marshall has a competing view of how markets adjust. Consider the single commodity case. For Marshall equation (iii) should be decomposed into two parts, individuals with a

positive excess demand (demanders) and individuals with negative excess demands (suppliers). For Marshall equation (iii) should be viewed as:

$$(vii) \quad X_d = \sum_{i \in \text{Demanders}} E^i(p_d, z^i) \text{ and } X_s = \sum_{i \in \text{Suppliers}} E^i(p_s, z^i)$$

Where  $(X_d, p_d)$  are the demand quantity and demand price at that quantity and  $(X_s, p_s)$  are the similar concepts for the supply side. Marshall then inverts and equates demand and supply quantities to get

$$(viii) \quad dX/dt = \lambda [p_d(X) - p_s(X)], \quad X = X_d = X_s$$

as a model to describe market adjustments. The quantity traded in the market is always equal for demanders and suppliers. If the marginal price that demanders are willing to pay is greater than the price at the margin that suppliers are willing to take then market volume goes up.

For the two commodity case (one good plus money) Figure 1 illustrates the two different models of price adjustment. For completeness, the cobweb model is added. As shown in the figure the Walrasian, Hicks, Samuelson model predicts that prices will adjust according to a speed dictated by excess demand. The Marshall model predicts that the quantity will adjust according to a speed dictated by the difference between demand price and supply price. Thus, they embody very different perspectives about how the price discovery process might take place and how adjustment in multiple markets can best be studied.

The different models have different consequences for instability. For cases like those in the figure the two sets of principles appear to lead to exactly the same conclusions, aside from possibly the speed of adjustment. However, that similarity is an illusion. The theories can lead to exactly the opposite conclusions about the nature and instances of market instability. In the case of upward sloping demands or downward sloping supplies they can give the exact opposite predictions. That property will form the basis for tests to be reviewed later.

Which of the two models is thought to be most applicable? Of course the Walras, Hicks and Samuelson model is the one found in common textbooks these days but it is not clear why. Certainly no data from the field has successfully separated the two models. As it turns out the Marshallian model is applicable for one broad class of economic environments and the Walrasian model is appropriate for another class.

### 2.3 The Cobweb Model

A third view of dynamics, based on lags of beliefs, has received attention in the literature. The cobweb model, holds that adjustment of supply in period  $t$  is based on the expectation that prices in  $t$  will be those that prevailed in period  $t-1$ . This model is not discussed since it does not produce instability if expectations are based on a weighted average of past prices (Carlson, 1967). In addition, predicted market instability has failed

to materialize under circumstances in which the model predicts instability. Typically, the cycling behavior it predicts develops slightly at first and then quickly dampens to the competitive equilibrium (Johnson and Plott, 1989). Thus, this particular model is not one that would be one of the firsts employed if problems in a field application of a new market mechanism are encountered.

### **Section 3. Can Markets Find the Zeros?**

From the point of view of the application, basic experimental work produced several essential facts that will be illustrated in this section. First, multiple markets organized by MUDA architectures exhibit a convergence process. They are orderly and the more agents that are present, the larger the volume, the more orderly are the markets. Rampant speculation, lack of coordination or confusion does not overwhelm the convergence tendencies. Secondly, the convergence process is exhibited over a series of market days or market periods. Time and replication play a role. The role played by replication is especially important for the design of new market mechanisms. The replication over time, in which the process starts fresh each day, differing primarily by the experience of the previous day, is a powerful feature of the convergence process. Third, the prices that emerge from multiple markets through the convergence process are close to those predicted by the general competitive equilibrium model. Fourth, the convergence can be observed in environments (not necessarily the gross substitutes case) for which the classical model cannot guarantee convergence. Thus, fortunately, the convergence process takes place in a wider range of environments than can be comfortably identified by theory.

All four of these features are reflected in the application presented in the last section of the paper. In this section two examples are reviewed as illustrations of how these messages have been delivered by broad-based research.

#### 3.1 A One Commodity Plus Money Example

For those that are not familiar with laboratory experimental methods a brief review of the case of one commodity (plus money) will be useful. Consider an economy with one commodity,  $x$ , and another commodity,  $M$ , that we will call money. In this case  $M$  is in fact U.S. currency. The preference function induced in the two dimensional space is of the form:

$$U^i(x^i, M^i) = f^i(x^i) + M^i$$

Where  $f^i(x^i)$  is the amount of money collected from the experimenter if the subjects ends the period with an amount  $x^i$  of the commodity. Thus, as long as the individual prefers more money to less the procedures induce the indifference curve implicit in  $U^i(x^i, M^i)$  in the  $\langle x, M \rangle$  space. Of course different individuals have different shaped functions depending on the purpose of the study.

In a simple demand and supply experiment some individuals, called demanders, are given initial endowments  $(x^i, M^i) = (0, M^i)$ . The demanders have money but if the prices of  $x$  are sufficiently low they maximize by trading money for the  $x$ . By purchasing  $x$  and cashing it in with the experimenter according to  $f^i(x^i)$ , they can increase their earnings. Other individuals called suppliers are given  $(x^i, M^i) = (x^i, 0)$ . The suppliers have  $x$  but might want to forgo the value of  $x$  in  $f^i(x^i)$  for cash if the price is high enough. The suppliers can make more money by selling  $x$  to the buyers than by cashing it with the experimenter according to  $f^i(x^i)$ .

If there are  $n$  subjects in an experiment, application of the competitive model contained in (i), (ii) and (iii) above collapses the  $2n+1$  equations of the model into two equations (market demand and market supply) and two unknowns (price of  $x$  and volume) since the price of  $M$  is one by convention.

An example should be useful. Suppose the function

$$(1) \quad f^i(x^i) = 100x^i - (x^i)^2$$

is assigned to some individual  $i$  with the units designated as U.S. cents. So, if the individual has one unit the value of the function is nine dollars. The individual is also given an initial endowment of  $(0, M^i)$  where  $M^i$  = some amount of money, say \$2.00 and the individual is also given an interest free loan of \$10 to use as transactions cash. The loan must be fully repaid at the end of a period. According to the competitive model this individual has a demand function, defined by (ii) above, which is of the form

$$(2) \quad x^i = 1/2(100 - P)$$

where  $P$  is the market price of the commodity  $x$ . This demand function can then be “summed” across individuals according to (iii) to create a market demand function for the commodity,  $x$ .

A similar exercise can be applied to those who have  $x$  as part of their initial endowments and thus have something to trade for money. Suppose an individual  $j$  is assigned a function

$$(3) \quad f^j(x^j) = 840x^j - 6(x^j)^2$$

and an initial endowment of  $(x^j, M^j) = (x^j, 0) = (60, 0)$  which is 60  $x$  and no cash. According to the model in (ii) the individual would supply  $x^j - x^j$ , up to  $x^j$ , according to the relationship

$$(4) \quad x^j - x^j = 60 - (70 - p) = -10 + P.$$

That is, the individual supplies nothing when the price gets below 10 but supplies directly according to  $p$  as the price increases.

The model of market price (general equilibrium) is based on the principles stated in (iii). The equations derived from the model of the individual demanders are summed to get an aggregate or market demand. The equations from the model of the individual suppliers are summed to get an aggregate or market supply. The law of supply and demand then states that the market will solve the equation that is formed by equating the market supply with the market demand, as is captured by (iii). That is, the market is supposed to

“discover” the price that forms the “zero” for that equation. Figure 2 illustrates the model for one buyer and one seller. Equation (2) becomes the market demand and equation (4) becomes the market supply and the equilibrium is approximately 40 for this numerical example of the theory, as is shown in the figure.

In the case of single markets this model is known to predict certain aspects of market behavior with remarkable accuracy. Figure 3 contains the results of one experiment. The solid lines represent the competitive equilibrium. The equilibrium remains constant for several periods and then the parameters are shifted so a different equilibrium is predicted. This particular market involved over 90 subjects. The period structure was also more complex than the classical period structure discussed above.

Two features of the market are clear from the figure. First, prices and volume involve movement. Secondly, the movements of prices are toward the equilibrium of the model. Prices converge to near the equilibrium. When parameters are changed and the equilibrium of the model is shifted upward the prices follow after a brief delay. When the equilibrium is again shifted near the end of the experiment, this time downward, the prices follow downward.

This experiment is of particular interest for two reasons. First, the number of people involved demonstrates that the convergence process takes place in the presence of large groups as well as the small groups of eight to fifteen traditionally studied. Second, the nature of time in this experiment is also important because the environment does not involve fixed periods. In this experiment the “periods” are not coordinated to be the same for all individuals.<sup>5</sup> Instead, one “generation” of buyers and sellers have incentives that last for periods  $t$  and  $t+1$ , getting a new set of incentives in  $t+2$ . The incentives come in the form of “orders” that appear in the private order book of a subject. A different “generation” has incentives that last for periods  $t+1$  and  $t+2$ , getting a new set of incentives in  $t+3$  (Aliprantis and Plott, 1992). This experiment is included here as a demonstration of an additional feature of robustness of the competitive model to rather dramatic alterations in the underlying economy and as a demonstration to those who might think that the convergence phenomena has some simple explanation like the fact that the period ends for all agents at the same time.<sup>6</sup>

---

<sup>5</sup> This experiment was conducted over the web using the Marketscape software that was designed explicitly for conducting market experiments. Incentives come to the subject in the form of “orders” from the experimenter that appear in an electronic order book that can be viewed only by the individual subject. The orders are similar to an offer from the experimenter to buy or sell units to the subject on the terms dictated by the order. The subject can then make money by arbitrage between the private orders in the subjects’ private order book and the offers made by other subject in the market. The structure of the experiment involved an “overlapping order” or “overlapping generations” structure. Subjects were divided into “generations” that can be identified as odd and even. The odd generations received orders/ utility functions at the beginning of odd numbered periods. These orders were good for the two following periods. The even generation received orders at the beginning of the even periods and were good for two periods.

<sup>6</sup> The robustness has been explored in many ways. See Jamison and Plott (1997), for example, where the equilibrium changed randomly from period to period and transactions costs were imposed with a purpose of impeding the convergence process. The competitive model still performs rather well under such adverse circumstances.

### 3.2 Multiple Markets and the Scarf Example

A natural question to pose is whether or not multiple market systems will exhibit a convergence process as do single markets. From the point of view of theory the challenge to markets depends on how the markets are interrelated as opposed to numbers or size. Experimentalists have met the challenge through the study of many different scales, in terms of numbers of markets,<sup>7</sup> and many different types of interdependencies.<sup>8</sup> The observations are that in all cases either equilibration or convergence toward the competitive equilibrium is observed. The literature demonstrates very clearly that in multiple and interrelated markets the general equilibrium model captures much of what is observed.

If the question is whether or not markets can find the “zeros” a large number of studies reports that the answer is “yes”. In this section we will introduce a very special economy that can be used to illustrate the ability of markets to equilibrate under theoretically difficult conditions. Then, the example will be used in later sections to illustrate principles that operate to guide the equilibration process. In those sections two related questions will be posed. Can markets find all of the zeros and are there situations in which the markets can find none of the zeros? The example developed here will be used to address these new questions.

An environment first discovered and studied theoretically by Herbert Scarf (1960) and extended by M. Hirota (1981) has very special (theoretical) dynamics. It provides a good window through which to view the behavior of multiple markets. The Scarf/Hirota market environments have been studied experimentally by Anderson, Granat, Plott and Shimomura (2000) and the data reported here are replications of their discoveries.<sup>9</sup>

The Scarf/Hirota environment has three commodities,  $x$ ,  $y$  and  $z$  with  $z$  being the numeraire in terms of which all prices are quoted. Since the price of the numeraire,  $z$ , is defined to be one, the system must find prices for  $x$ ,  $P_x$ , and prices for  $y$ ,  $P_y$ . Of course

---

<sup>7</sup> Plott (1988) studied an economy with nineteen markets. Plott and Porter (1994) studied an economy with eighteen markets. The use of Marketscape and supporting methodologies have allowed the creation and study of economies with hundreds of markets.

<sup>8</sup> The first multiple market experiments were conducted in the mid 1970s, which were also the first asymmetric information experiments, Plott and Wilde (1982). Forsythe, Palfrey and Plott (1984) studied an exchange economy with two goods, a spot contract and a futures contract. Plott (1988) studied a decentralized system of nineteen complementary markets in a network for natural gas transmission. Goodfellow and Plott (1990) studied derived demands. Lian and Plott (1998) studied general equilibrium systems with a fiat money and Noussair, Plott and Riezman (1995,1997) studied systems of international trade and international finance with multiple fiat moneys and exchange rate determination. Williams, Smith, Ledyard and Gjerstad (2000) studied experiments with a two dimensional commodity space with CES preferences.

<sup>9</sup> Strictly speaking the experiments reported here are more of a robustness check since they were produced by the internet Marketscape program for the multiple unit double auction and the original experiments were conducted using MUDA on a local area network. There are several subtle and potentially important market architecture differences related to the speed with which bids and asks can be known, the existence of an open book, the process of training subjects, etc. All subjects in the experiments reported here were inexperienced.

both the price of x and the price of y are quoted in terms of z per unit. Three types of agents exist in equal numbers in the economy, five of each type for a total of fifteen people.

Preferences over multi-dimensional commodity spaces are induced in a direct way using monetary incentives. In the Scarf case they have a very special form. The preference maps are illustrated in Figure 4 and in Table 1. Type I person has preference for y and z while getting no utility at all for x. Specifically Type I has the utility function (and it is the one used in the experiments)  $U(y,z) = 40 \min \{y/20, z/400\}$ . Type II gets utility from x and z and receives no utility from y with the utility function  $U(x,z) = 40 \min \{x/10, z/400\}$ . Type III gets utility from only x and y, having utility function  $U(x,y) = 40 \min \{x/10, y/20\}$ . These are the actual incentives used each period with the units denoted in cents.

The reader will notice immediately from Figure 4 that these preferences do not exhibit the gross substitute property that theoretically guarantees convergence according to the classical models of stability. However, as Hirota has shown, such a general equilibrium system will theoretically converge if the correct initial endowments exist. One such case is when each agent is endowed only with the commodity for which he/she receives no utility. Such initial endowments are points C in Figure 4.

The first multi-market experiment to be reviewed has the initial endowments like point C, the convergence case in Table 4. When the principles (i), (ii) and (iii) of the general equilibrium model are applied the unique solution to the equations with strictly positive prices, is a price of x,  $P_x = 40$ , and a price of y,  $P_y = 20$ .

The data in Figure 5 reproduces the results of one experiment, which is typically of those reported in the literature (Anderson, Granat, Plott and Shimomura, 2000). The equilibrium prices are shown as the dotted lines. The horizontal axis is time and each dot represents a contract in the market. The periods are designated near the bottom of the graphs.

As can be seen the prices begin with substantial variance. The price of x starts low and immediately increases to levels on the order of twice the equilibrium price of 40. However, by the fourth period the prices have converged almost perfectly to the predictions of the competitive equilibrium model. The circles at the top of the figure are not particularly informative for this experiment but were included for comparison with discussions of experiments presented in later sections.

The conclusion of this exercise is that in multiple market systems the price discovery process can result in the patterns of zeros predicted by the general competitive equilibrium model. In particular, markets can attain the competitive equilibrium in the Scarf environment, a fact that will become more important after a discussion of dynamics and the process of price discovery. In a sense, the illustration presented in this section is a baseline for comparison with the experiments discussed in later sections in which the initial endowments are different.

### Section 3. How Do Markets Do It? Principles of Market Adjustment

How do markets find the zeros of the appropriate equations? From the point of view of the applied problem the question is important. Much of the data produced by markets reflects a process of convergence. If unexpected phenomena are observed then models of adjustment will be fundamental to any attempted diagnostic. Furthermore, an understanding of the possible mechanisms at work in the adjustment process can be useful in the development of experimental “stress tests” of a mechanism. By conducting experiments in environments in which the mechanism is likely to exhibit poor performance according to theory, a better understanding of the robustness of the mechanism might be gained.

The answer to the question of how markets find the zeros resides in the dynamics of price adjustments, as is suggested by the nature of convergence reported in the sections above. The major result reported in this section is that classical models of market dynamics explain important qualities of what is observed. Thus, the (current) answer to the question of how markets do it, is that price discovery takes place as a result of the properties of price movements as opposed to technical aspects of the equilibrium itself<sup>10</sup>, and that those principles are represented by classical models.

Classical models are probably not the end of the story. As data and theory advance more successful general models of dynamics could emerge. In particular there is an intense focus on the micro-micro structure of the price discovery process involving both game theory and artificial agents. Useful insights have emerged. For example, it has been demonstrated that convergence can take place even in the presence of considerable error at the level of individual decisions but no principles have emerged that satisfactorily connect actions at the individual level to the convergence process.<sup>11</sup>

Classical models of dynamics make very sharp predictions about stability. We will first review the results of single markets. By studying competing predictions about stability one can perform a clear test between the models. The first case involves a single market with multiple equilibria. The second and third cases will be of the three commodities, in a Scarf environment, in which the model predicts that orbiting behavior of prices will be observed. The Scarf environment is of particular interest because it suggests a case in which a prominent competitive equilibrium will not emerge. That is, if the competitive

---

<sup>10</sup> For example, the equilibrium itself could be defined as the quantity demanded at a price equals quantity supplied (Walras) or demand price equals supply price (Marshall) or as the intersection of demand and supply correspondences (Debreu). Which of these definitions used in models might not be so important as the implications the definition holds for price movements.

<sup>11</sup> Models that attempt to explain and predict the choices of individuals in the convergence process have been successful only to a limited degree. See Easley and Ledyard (1993), Friedman (1991), Cason and Friedman (1993, 1996, 1997). A recent approach has been to study the complexity through the design of robots that do the bidding. The approach leads to a deeper insight of the behavior in relation to institutions (Gode and Sunder, 1993, 1997) and Gjerstad and Dickhaut (1995).



process is based on principles of classical dynamics, then within a stationary process the market will not discover a solution to the general equilibrium equations.

The sections below will develop three points. First, market prices can exhibit the type of instability predicted by classical dynamic models. Second, the appropriate model, Marshall or Walras, depends on properties of the underlying demand and supply. Instability is typically associated with special shaped curves such as upward sloped demand or downward sloped supply. If the special shape is due to the existence of an externality such as a fad or a Marshallian external economy then experiments have demonstrated that the Marshallian model is the appropriate model. If the special shape is due to income effects then the appropriate model is the Walrasian model as opposed to the Marshallian model. That is, if the special shape is due to income effects such as Giffen goods or a backward bending supply of labor then the Walrasian model reflects the appropriate principles. Third, the paths that prices follow in a multi-market economy (with no externality) are similar to those suggested by the Walrasian, Hick, Samuelson model of dynamics. In particular, if the path does not lead to equilibrium, even when that equilibrium is prominent, the markets might not find it, or so the data suggest. In summary, the mystery of the price discovery process is solved, in part, by classical models of adjustment.

The case of the market externality, in which the Marshallian model of adjustment is known to be appropriate (Plott and George, 1992; Plott and Smith, 1999) is not reviewed here. In part it is because there is no generalization of the Marshallian model to the multimarket economy. At least, if there is such a model I am unaware of it. This omission does not mean that the issue is unimportant. The ultimate application to be reviewed involves information aggregation, which might function as an externality. Thus, an entirely different dynamic could be involved in the world of information revealing prices. The experiments to date only warn of the possibility.

### 3.1 Marshallian Stability vs Walrasian Stability: The Single Commodity Case

In the single commodity case the models have very sharp predictions that can be used to create experiments that separate them.<sup>12</sup> Figure 6 illustrates the nature of the tests. Shown there the supply curve has a downward slope induced by preferences that produce the “backward bending” supply. A complete description of the preferences can be found at (Plott, 2000a).

From the discussion and the preferences in Figure 4 the reader can imagine how different shaped indifference curves can be induced and, in particular, can imagine how shapes can be chosen such that they produce the theoretical supply curve found in Figure 6. The experiment begins with the parameters represented by the supply curve  $S$  and the demand curve  $D_1$ . Then, after several periods the demand curve is changed to  $D_2$  with the supply

---

<sup>12</sup> In a very early paper Vernon Smith (1965) conducted experiments on the nature of dynamic adjustment but his design was inadequate for separating the competing theories and his econometric analysis misled him about the phenomena. He mistakenly rejected the Walrasian model.

curve remaining at  $S$ . After a few more periods the demand curve shifts back to  $D_1$  and the supply curve still remains at  $S$ . As these shifts are made the stability of all equilibria shift between stability and instability.

Notice first that there are several equilibria. On the left are points  $a, b$  and  $d$  are all equilibria but the stability properties differ. Under conditions  $D_1$ , points  $a$  and  $d$  are Walrasian stable and Marshall unstable. Point  $b$  is Walrasian unstable and Marshall stable. By contrast, under conditions  $D_2$  the equilibria are points  $a, b$  and  $c$ . Points  $b$  and  $c$  are Walrasian stable and Marshallian unstable. Point  $a$  is Walrasian unstable and Marshallian stable. Thus, for each of these equilibria the two models always give exactly the opposite predictions about stability. Other equilibria exist on the boundaries but these will not be discussed.

The nature of the exercise is to start with the parameters  $D_1$  and  $S$ . If the market converges to one of the equilibria it will be a stable equilibrium according to one of the models. Prices should only converge to a stable equilibrium and thus convergence to one of the points will lend support for one of the models and evidence against the other. After the shift the stability properties of all equilibria are reversed so the equilibrium where the prices exist will become unstable according to the model that had previously been supported. Thus, if the principles of the model were active then one would expect the prices to move away from the equilibrium toward one of the other stable equilibria of the model.

The basic result is that the data from experiments support the Walrasian model and not the Marshallian model. The data from a representative experiment are reproduced in Figure 7. As can be seen, when the markets begin under demand condition  $D_1$ , prices converge to point  $a$ , an equilibrium that is stable according to the Walrasian model and unstable according to the Marshallian model. When the demand shifts to  $D_2$  and point  $a$  becomes an unstable equilibrium according to Walras (stable according to Marshall) the data move rapidly upward toward the stable Walrasian equilibrium that exists at point  $c$ . Such exercises produce strong evidence for the Walrasian model.

Additional exercises represented in the figure give additional support for Walras. About period 12 under demand conditions  $D_2$  a price ceiling was imposed on the system just below the Walrasian unstable equilibrium at  $a$  and as can be seen prices bumped against the ceiling and then immediately fell to the nearest Walrasian stable equilibrium at  $b$ . The price ceiling was removed during period 16 and prices jumped over the unstable equilibrium at  $a$  and moved toward the stable equilibrium at  $c$ . To complete the demonstration the demand parameters were returned to  $D_1$  and a price ceiling was imposed just below the resulting unstable Walrasian equilibrium at  $b$ . The result was that prices fell to the Walrasian stable equilibrium at  $d$ . Removal of the price ceiling in the final period resulted in prices jumping away from the Walrasian stable  $d$  equilibrium to the stable  $a$  equilibrium. Thus the behavior is rather unintuitive, since high prices forced down by a price ceiling and without and demand or supply change resulted in prices

falling still further. When the (nonbinding) ceiling was removed, prices jumped up<sup>13</sup>, moving toward and then through an unstable equilibrium and then on to a different stable equilibrium

Such an exercise demonstrates three points. First, market equilibria can exhibit instability. Secondly the nature of the instability and stability in this type of environment is captured by Walrasian adjustment as opposed to Marshallian. Third, there is something wrong with the theory because jumps across unstable equilibria should not occur. But, such jumps are observed. Evidently the principles of dynamics are not restricted to “local” dynamics. Thus, the theory is partially misspecified.

### 3.2 Classical Dynamics and Scarf Orbits

Recall from the discussion in Section 3.1 the Scarf environment involves three types of agents and three commodities,  $x$ ,  $y$  and  $z$  with  $z$  defined to be the numeraire in terms of which all prices are quoted.

When applied to the Scarf environment the classical dynamic model as developed by Scarf and extended by Hirota and by Anderson, Granat, Plott and Shimomura (2000), produces stark predictions about market behavior. According to the model, by simply rotating the initial endowments the prices in the experiments will exhibit convergence to the equilibrium, counterclockwise orbits or clockwise orbits, depending only on the initial endowments chosen. These predictions are defined in Table 1. The related initial endowments are also contained in Figure 4, labeled as C for convergent, CCW for counterclockwise and CW for clockwise.

If all agents are endowed with the commodity that they do not like then the classical dynamics model has prices converging directly to the equilibrium. If agents are endowed with one of the commodities they like and neither of the others, then the model has prices orbiting around the equilibrium in a clockwise direction. If agents are endowed with the other commodity they like, then the model has prices orbiting around the equilibrium in a counterclockwise direction. Thus, in the case of orbits, the model predicts that the unique general equilibrium with positive prices will not emerge. In principle, the markets cannot “find” it.

Figure 8 demonstrates the nature of the theoretical proposition for the orbiting case. Shown in the figure is the two dimensional plane of price ratios. On the vertical axis is the price of  $y$ . Actually, it is the price ratio between the price of  $y$  and the price of  $z$ , the money in the economy, but the price of  $z$  is one. Shown on the horizontal axis is the price of  $x$ . The dot in the figure is the vector of equilibrium prices according to the general equilibrium model.

---

<sup>13</sup> Isaac and Plott (1981) were the first to report the fact that a non-binding price control can have surprising effects on a market. The fact that removal of the non-binding controls could cause a switch in the equilibrium selected was new with the demonstration shown in the figure.

The orbit around the equilibrium price vector is representative of behavior predicted by classical principles of dynamics. The particular shape is dictated by the  $\lambda_{ik}$ 's contained in (iv) in section 2.2 above. It is the theoretical existence of such paths that Scarf discovered. If prices move in the clockwise direction the orbit is called clockwise and if the movement is in the other direction it is called counterclockwise.

Figure 9 illustrates a representative, theoretical, counterclockwise orbit in time space. As can be seen the behavior of prices in the model has the prices of the two commodities moving in uniquely coordinated waves through time that produces the orbit. The small circles at the top of the figure are an illustrative methodology for relating the prices at some instant in time to the directions that the orbiting model predicts prices will move. The vertical line inside the circle represents the equilibrium price of  $x$  so if prices are to the left the price of  $x$  is below equilibrium and to the right, above. The horizontal line represents the equilibrium price of  $y$  with point above or below representing prices above or below equilibrium. If the price vector is in the lower left quadrant, prices of both  $x$  and  $y$  below equilibrium, then if the movement is counterclockwise the price of  $x$  should go up and the price of  $y$  down.

The question posed by experiments has been whether or not such price movements can actually be observed. The rather amazing answer is "yes". When the model predicts counterclockwise price movements, such movements are observed in the markets. Alternatively, when the model predicts clockwise movements then the clockwise movements appear in the data.

A counterclockwise example is illustrated in Figures 10A and 10B. The initial endowment parameters are those for the CCW case as shown in Figure 4. Figure 10A contains each transaction price in each market at the time the transaction took place. Prices in the two markets open with the prices in the  $x$  market tending to be slightly above the equilibrium price and the prices in the  $y$  market below the equilibrium price. According to the counterclockwise orbit both prices should move upward and as is reported in the figure, that is what they do. The upward movement continues until the  $y$  market reaches the equilibrium level of the  $y$  price and at that time the price in the  $x$  market should begin to fall as the  $y$  prices continue to increase. Again, that is roughly what takes place. The circular figures above the time series illustrate the location of the price vector relative to predicted movements at various points in time. As can be seen the prices move in the directions predicted by the Scarf model.

Figure 10B contains the average price for each market and each period. In this figure the counterclockwise movement is easy to see. Prices begin with the  $y$  market below equilibrium and the  $x$  market slightly above its equilibrium. The orbit can be seen as it traces out an elongated shape with the price of  $x$  going much higher than it would if the orbit had been a circle. Such elliptical shapes do occur in experimental markets but such elongated ones are rare in the data that have been collected.

A clockwise example is illustrated in Figures 11A and 11B. Again, the parameters are as illustrated in Table 1 and Figure 4. Figure 11A contains the time series of individual

transactions and the Figure 11B contains the average prices in each market for each period. As can be seen in Figure 11A, prices in the two markets begin at about the same levels with the prices in the x market below the equilibrium for that market and the prices of y slightly above the equilibrium for the y market. The clockwise model (as shown in the circular figure at the top of the graph) predicts that both prices will move upward and that is what happens, with the y market moving upward much more rapidly than the x market. Both markets move up until the x market reaches a level near its equilibrium where the y market begins a downward trend as predicted by the clockwise model. The x market prices continue to go up until the y market has reached levels near its equilibrium, as predicted by the model. The panels in the upper part of the figure illustrate the location of the price vector as time progresses. The prices are moving in the clockwise direction as predicted by the model.

The clockwise orbit can be seen very clearly in Figure 11B. The average price of y moves up rapidly while the average price of x slightly decreases and remains constant. Then, the average price of x increases while the average price of y remains essentially constant thereby creating a box-like, clockwise orbit. What governs the shape of the orbit is completely unknown at this time but the orbiting property itself, in a clockwise direction as predicted by the Scarf model, is unmistakable.

### 3.3 The Current Solution to the Puzzle

The data reviewed here tell us that the mystery of how markets solve the set of general equilibrium equations is resolved in part by the classical models of dynamics. The key is the Walrasian model as generalized Hicks and then by Samuelson.

When the classical Walrasian model predicts that an equilibrium in a single market will be stable, stability is observed. When the model says that the market equilibrium will be unstable, instability is observed. Furthermore, the markets respond to interventions like the price controls, in a manner predicted by the this model. The illustrations were those presented in Figure 7.

The generalization of the model to multiple markets continues to predict what is observed. When the classical dynamic model says that the system will converge to the equilibrium, the system is observed to converge, as was shown in Figure 5. When the model says that the prices will move in a counterclockwise direction, such movements are observed, as was illustrated in Figure 10, and when the model says that the movements will be in the clockwise direction, it happens, as is shown in Figure 11. Samuelson, when generalizing the work of Walras and Hicks, had only analogies from physics and his intuition. The data presented here suggest that he was on the right track.

A major question remains outstanding. Can markets fail to find any equilibrium even when one exists? We know that it cannot find all equilibria because it cannot find the unstable ones. However, if the Scarf model is correct then there are circumstances in which an equilibrium will not be found because prices will only orbit.

The question is whether or not the prices are following an actual orbit as opposed to slowly spiraling into the equilibrium, and the answer to this question is unknown. Thus far, it has not been possible to conduct experiments sufficiently long to determine the answer. Nevertheless, evidence developing from the work of Bossaerts, Plott and Zame (2001) suggests that the prices are spiraling in to the equilibrium. Estimates of the four parameters,  $\lambda_{11}$ ,  $\lambda_{12}$ ,  $\lambda_{21}$ ,  $\lambda_{22}$ , in (vi) suggest that the off diagonal elements are significantly non zero. That is, proposition (v), that the off diagonal elements are zero, is being rejected. This would mean that the adjustment in one market depends on the excess demand of other markets. Clearly, the full implications of such an amended theory are unknown but initially, it appears that markets might be characterized by more stability than the classical theory would lead us to believe.

Before leaving this section another observation should be made. The classical models of adjustment were developed under the assumption that the mechanism was tatonnement, without disequilibrium trades. Of course, the double auction involves trading out of equilibrium, which had the effect of changing the initial endowment. For the moment we can conclude that the tatonnement model is a powerful tool even though it should not be. We wait for a theorist to tell us if a non-tatonnement model can do a better job of explaining what we see.

### **Section Five: Can Markets Aggregate Information?**

The suggestion that markets might be created specifically to aggregate information has roots in a long history of experimental economics research. Plott and Sunder (1982,1988) made two discoveries. First, that markets can aggregate information and second that the ability of markets to do so is related to the underlying instruments that exist in the market. An impressive literature has developed since (Copeland and Friedman, 1987, 1991, 1992; Forsythe and Lundholm 1990; Friedman, 1993; Sunder 1992, 1995; Noth and Weber 1996, Plott 2000b). While this literature establishes the ability of markets to carry information from insiders to outsiders, it is also known that markets can make mistakes (Camerer and Weigelt 1991). Furthermore the large literature on the winner's curse and cascades that has developed since these were first discovered experimentally (Kagel and Levin, 1986; Anderson and Holt, 1997), tell us that the ability of markets to perform this task is related to the underlying market architecture. Sealed bid processes, for example, and perhaps call markets in general, will not be an effective architecture. The cause of mistakes systematically made by agents, the detectability of mistakes and the relationship between market architectures, market instruments and the information transmission process contains huge categories of unexplored issues.

Roughly speaking, the literature suggests that markets with instruments consisting of a full set of Arrow–Debreu securities and organized as continuous, multiple unit double auctions have the capacity to collect and aggregate information. The ability to perform the function is related to replication of experiences similar to the convergence exhibited by all experimental markets. Historically, the early experiments focused on only a small

number of states, a small number of traders and few markets reflecting the limitations of experimental technology. However, with the development of the Marketscape programs in the early 1990s, much larger experiments became possible.

The illustration included here was part of the experimental tests conducted prior to the implementation of the applied project discussed in the following section. Among other things the experiment was used as a test of robustness of earlier results referenced above.

The experiment proceeds in a series of periods or “days”. The economy consists of 10 states. A state is randomly drawn at the beginning of each period. Specifically, all states are equally likely. The state drawn is unknown to subjects but each individual is given an independently drawn signal dependent on the state. The signal given to an individual consists of three draws with replacement from a distribution with the correct state having a probability of one fourth of being drawn and each of the other states having a probability of one of twelve. So, an individual with three draws of the same state has a posterior probability of 0.75 of knowing the state. If the individual has two draws the same then the probabilities are 0.45 , 0.15 and 0.05 for the three types of states represented. If the individual gets three separate states drawn then the probabilities are 0.188 and 0.063 for those represented and those not represented respectively.

Thus, each individual has very little information about the state. Even an individual with all three draws the same has a .25 chance of being wrong. However, if there are many individuals and if the draws of all individuals are pooled together then an application of Bayes Law to the pooled samples will give the true state with near certainty. Thus, the experimental environment is one in which each individual knows “very little” but “collectively” they know a lot. If the markets collect and reveal all information that is known to all individuals then the true state should be revealed in the prices with almost certainty. That is, the true state should be revealed with almost certainty if the principles of rational expectations information aggregation are in operation.

The instruments are Arrow-Debreu securities. Each state is represented by a security that pays \$2.00 if the state occurs and \$0 otherwise. Each agent is given an initial endowment consisting of a portfolio of 10 of each type of securities. By holding the full portfolio and making no trades at all, the portfolio would pay \$20, which would allow the individual to repay the \$10-\$15 loan for the period. The rational expectations, fully revealing competitive equilibrium is for the price of the security representing the true state to be near \$2.00 and the price of securities representing all other states to be near \$0.

Figure 12A contains a typical time path of the ten markets when the agents in the markets have had some experience. Opening prices exhibit considerable variance with some prices being much too high, often due to entry errors but sometimes due to agents who had strong signals. All prices tend to drop and as the cluster of prices drop and occasionally a price will move upward only to be competed back down. Eventually one price begins to emerge and move upward steadily and when this takes place it is almost always the market of the true state. In Figure 12A this is the Z market. State Z has a .99 chance of being the true state according to the pooled information that was sent privately

to all agents. In the figure a second market, S, begins to emerge with a higher price. While the price of Z and the price of S sum to near the 200, the sum is not perfect and certainly the price of S is too high given the information in the system. In the sense of these time series, one can say that the markets managed to aggregate the information and make it available for all. The aggregation is not perfect but it is useful.

Figure 12B contains the results of an experiment with over 60 subjects for a number of periods. Subjects were located remotely, participating through the internet. Before a period opened each subject received private information about the state as described above. They were given the initial endowment portfolio for the period, a loan of working capital and the results of any previous period states and their own earnings. The figure contains the results of eight periods. The time sequence for each market is shown in the figure.

As can be seen, during the first periods prices reveal very little. Almost all prices are roughly at the same level. However, even in the early periods a trained eye can detect the proper state by the behavior of the prices. Not shown in the figure are the bids and asks, which are known to be important carriers of information in addition to prices. By about the fourth period the price of the correct state emerges very quickly in the period and moves to near the rational expectations level. The prices of all other states fall toward zero. By the final periods the information becomes aggregated quickly in the prices and even those with no information at all can infer what others know from the behavior of the markets.

While experiments demonstrate that properly designed markets have the capacity to collect, aggregate and publish information the experiments also demonstrate that there are limitations. Bubbles can be observed in experiments in which the wrong market emerges with a high price and strongly signals the wrong state. However, it must be added that such events are rare, given strong underlying information and they are reduced with experience. Nevertheless, the dynamics of the information aggregation process are not understood. Even though we have some models of the price discovery process the principles at work as information is produced are just beginning to be explored.

### **Section Six: Are The Lessons From The Simple Cases Useful?**

The experimental work suggests that markets have the capacity to collect information through a process of equilibration. The ability to do so is not perfect and it might require special market institutions but, nevertheless, the capacity is there. Such facts suggest the feasibility of creating a system of markets that have only a purpose of gathering information. That is, the laboratory work suggests that theory and experiments can be turned to the design and implementation of *Information Aggregation Mechanisms*.

The issue of whether or not laboratory methods are useful can now be brought into view. The idea of an information aggregation mechanism as a product of institutional design is a direct product of experimental work. More importantly, the implementation of such a



mechanism would not exist in the absence of laboratory experiments. The section above demonstrates the capacity to create multiple markets in which specially crafted instruments are traded by remotely located agents. Furthermore, the section demonstrates the capacity to deploy a large system of markets, which operate in real time, and manage it with the care and timeliness required by experimental methods. The existence of such abilities responds to the issue value created by experiments.

Background laboratory work established the two important legs for an application.<sup>14</sup> First, the laboratory work established a “proof of principle” in the sense that once created a system of markets produced the type of information that a properly functioning Information Aggregation Mechanism should produce. When tested under laboratory conditions it performed as predicted. Second, the experiments established “design consistency” in the sense that the mechanism performed as it did for understandable reasons. While the theory that we have is substantially incomplete, what we do have seems to work within reasonable tolerances. The success of the mechanism does not appear to be some sort of accident or accidental choice of parameters.

Experimentalists in Hewlett Packard Corporation were aware of the potential value of developing and deploying an Information Aggregation Mechanism. They decided that a field test would be appropriate and management was approached accordingly. Experimental evidence was used in discussions with management, which were concerned about cost and potential benefits to the business. Criteria for finding the appropriate problem were closely linked to the properties that existed in successful laboratory experiments. The state of nature should be objective and not too far in the future, reflecting the fact that participant experience might be necessary for mechanism success. In addition, the state forecasted should be replicable in the sense that the same type of forecast should be undertaken repeatedly with the same participants. Those participating in the forecast should possess information that can be aggregated. The Information Aggregation Mechanism involves information collection and aggregation but not information creation. The forecast would reflect information collected and if no information existed to be collected, then there would be no reason to think that the forecast would be successful.

The applied problem chosen for field tests was related to sales forecasting. In the context of the application, the company would like to obtain information about the sales of a particular piece of equipment a few months in the future. Managers think that information exists in the form of intuition and opinions of the sales force who see the customers face to face. Additional people in the marketing chain also have opinions that can reflect information. Given the circumstances, meetings are not feasible. Questionnaires are not particularly useful since often incentives are lacking as are abilities of individuals to express qualitative opinions in a quantitative way. Thus, the

---

<sup>14</sup> Considerable thought has been devoted to the methodology of using experiments in policy contexts. The concepts of “proof of principle” and “design consistency” are introduced by Plott (1994). For the most part the approach (mine at least) has been to deliver examples as opposed to try to describe the methodology in abstract terms, however, an introductory exposition can be found at Plott (1999). The interested reader can find many examples in Plott (2001).

belief was that information existed to be collected but collecting by traditional methods had not been successful.

The mechanism was based on a clear identification of the equipment for which sales were to be forecast and the personnel who might have information about possible future sales. There were Hewlett Packard personnel who were involved in the sales process. For purposes of the example used for this discussion the equipment will be called “Low” and the month for which sales were to be forecast was September. The month in which the markets operated was June. The possible sales were divided into intervals such as 0000 – 1500; 1501 – 1600; 1601-1700; etc. up to 2301-more. From the point of view of the theory these intervals can be identified as the “states of nature” but of course that language was not used in the field.

The mechanism was based on ten securities. Each state of nature was associated with a specific security and the associated security was given the name of the state. So, there was a security called, SEP-LOW-0000-1500 and one called SEP-LOW-1501-1600, etc. After the actual sales for the month of September were to become known the security associated with the state would pay a dollar per share to the holder. Those securities associated with all other states would pay zero.

Thus, the situation is exactly a full set of Arrow-Debreu securities as described in the experiment above. Figure 13 contains the list.

From a technical and procedural point of view the field test was a direct extension of those developed for laboratory use. Each of the individuals identified for the exercise was given a portfolio of approximately 20 shares of each security and some trading cash. They were trained in the operations of the Marketscape programs, which were used to support continuous trading in all of the markets simultaneously. With each trade the cash and the securities changed hands immediately. Unfilled orders were registered in the order book for the appropriate market that was available for all to see. Of course many aspects of the application were specific to the application. The timing of the markets, special screens, special training and online help were developed. Links to the company database were provided for those who wanted to study such data that the company had for processing and applications for forecasting. The time line of the exercise had to be consistent with the potential use of the data. In fact the exercise involved several different forecasts over a period of time. Overall, there were many differences with laboratory exercises, which lasted from one to three hours and then were over.

Figure 14 contains the closing display on the software that participants used for trading. The prices listed there were part of the ingredients for the September-Low predictions. For each market the bid (best buy offer), ask (best sell offer) and the price of the last transaction in that market are displayed. For example, in the SEP-LOW-1601-1700 market the bid was 14 cents each for up to 5 units, the ask was 25 cents each for up to 10 units and the last trade was at 14 cents.

The security representing the correct state pays 100 cents. All prices should be between 0 and 100. Thus, prices can be interpreted as probabilities. In particular one can interpret the 14 cent price that existed in the SEP-LOW-1601-1700 markets as a "market belief" that with probability .14 the sales in September will be in the interval 1601-1700.

It is easy to understand the process of prediction if final prices are interpreted as probabilities of the states. With such an interpretation the mode of the predicted sales occurs at SEP-LOW-1901-2000 at a probability of .22. The distribution itself is skewed to the states higher than the mode. Thus, one could predict the most likely state, which would be the security with the highest closing price. Of course there are many other statistics that can be used, and the Information Aggregation Mechanism produces additional data such as the time series of trades, bids and asks, as well as the trading patterns of individual participants, all of which can be used as the basis for forecasts.

The mechanism has performed well inside Hewlett Packard Corporation with a total of sixteen predictions. The predictions from the mechanism have been better than the official forecasts in all but one occasion. Research has continued in an attempt to design mechanisms that collect data faster and can be used to forecast more complex events and in cases in which fewer informed people might be participants than markets. Markets perform best if the markets are "deep" and so an improved mechanism would deal with the "thin market" cases.

The complexity of field applications should not be minimized. There are many differences between the laboratory environment and the field environment. In the laboratory it was known that information exists to be collected. That is not the case in the field. In the laboratory the information is known to be independently distributed and that there is a value to collection and aggregation. That is not known about the field. In the laboratory the time, attention and training of the subjects is all controlled. Certainly that is not the case in the field. In the laboratory the subjects have no incentive to manipulate the outcome but in the field they might.

Thus, by no means does success in the laboratory guarantee success in the field. The laboratory cannot be used to solve all problems but that is not the thesis advanced here. The example is only intended to demonstrate that the results of the laboratory can be useful.

## **Conclusions**

While the topic of this paper is the behavior of certain multimarket systems, the substance of the paper is about the application of laboratory experimental methodologies in economics. Experimentalists in economics study simple and special cases, just as the experimentalists in any branch of science study simple and special cases. As such, the ultimate value of experiments is achieved in an indirect way. Experiments teach us about the principles that govern the phenomena, and the hope is that the principles extracted from the study will be helpful in understanding the complex. The effort is indirect in the

sense that experiments teach us about theory and it is theory that we use when addressing complex and new problems. The progress builds in slow and in unexpected ways.

The experiments reviewed here remind us that economics has much to say about interdependent systems and the role of institutions in guiding the performance of the systems as opposed to the behavior of individuals acting in isolation. Not only are there rather remarkable principles that govern the behavior of economic systems, it is hard to reduce those principles to propositions about the behavior of individuals, propositions from game theory or even propositions about the behavior of individual markets.

Three types of principles emerge with regards to markets organized as continuous double auctions. First, multiple market systems exhibit tendencies to move toward the equilibrium of the classical, competitive general equilibrium model. The coordination features implicit in the set of simultaneous equations can be identified in behavior. Second, markets exhibit disequilibrium behavior that is captured, in part, by the classical models of dynamics. Markets are not always in equilibrium and in fact the nature of equilibrium resides in the nature of the movement of markets. Third, markets exhibit an information gathering feature. Individuals acquire the information possessed by others by simply watching and interpreting their behavior. The dynamics of this process and how it interacts with other features of market dynamics is substantially unknown, to experiments at least.

Amazingly, many features are captured by models developed under the assumption that the economies operate through a process of tatonnement, which of course, they certainly do not. It is even more amazing that the principles as developed by Marshall, Walras, Hicks, Samuelson, Arrow and Hurwicz were derived without the benefit of laboratory experimental data.

The results might be interpreted as a complete embracing of classical economic theory but such an interpretation may be premature. Experiments have demonstrated that markets have a sensitivity to market microstructure, architectures and instruments in ways that are not predicted by the models that have otherwise proved so successful. Some forms of market institutions operate more efficiently than others and such influence of institutions is not well understood from the point of view of theory. So, while the principles tell us that certain types of markets can have remarkable capacities, it does not follow that all forms of market organization do. While classical theories can do a good job of helping us understand and predict how some markets function, it remains to be determined how those theories extend to other market forms.

Of course much of this review is about experiments and how the impact of basic science is often subtle and takes place over long periods of time. The attempt of this paper has been to illustrate how the impact accumulates and can result in surprising and valuable applications. By drawing on specific scientific results, it was possible to create something valuable. The science made it possible to design, develop and implement a completely new type of market function- the Information Aggregation Mechanism. The class of such mechanisms has since been extended (Plott, Witt and Yang, forthcoming).

The uses of laboratory experimental testbeds in the development of applications and new types of mechanisms are advancing.

The experiments do have implications for the broader context of market economies. Information aggregation has immense implications for the efficiency with which social processes operate. No doubt, markets that have evolved naturally in response to historical events are highly efficient information transmitters in many cases. Hopefully, the experiments will give us better tools with which to understand how and why they function as they do and give the economics community insights to know when existing markets might be improved and when markets produced by history are better left untouched.

## References

- Aliprantis, Charalambos D. and C. R. Plott, "Competitive Equilibria in Overlapping Generations Experiments." *Economic Theory* 2 (1992):389-426.
- Anderson, Christopher M, S, Granat, C. R. Plott, and K. I. Shimomura, "Global Instability in Experimental General Equilibrium: The Scarf Example." Social Science Working Paper no. 1086. Pasadena: California Institute of Technology. Revised September 2000 and submitted for publication.
- Anderson, Lisa, and C. Holt, "Information Cascades in a Laboratory." *American Economic Review* 87, 5 (December 1997):847-62.
- Bossaerts, Peter L., C. R. Plott, and W. Zame, "The Role of Excess Demand in Determining Marginal Price Changes in the Equilibration of Competitor Markets." California Institute of Technology, Pasadena, California (2001).
- Camerer, Colin F, M. Nöth, C. R. Plott, and M. Weber, "Information Aggregation in Experimental Asset Markets: Traps and Misaligned Beliefs," Social Science Working Paper no. 1060. Pasadena: California Institute of Technology, April 1999.
- \_\_\_\_\_ and K. Weigelt, "Information Mirages in Experimental Asset Markets." *Journal of Business* 64:463-93.
- Carlson, John A., "The Stability of an Experimental Market with a Supply-Response Lag", *Southern Economic Journal*, 33, 3 (January 1967):305-321.
- Cason, Timothy. N. and D. Friedman, "An Empirical Analysis of Price Formation in Double Auction Markets, The Double Auction Market: Institutions, Theories and Evidence," D. Friedman and J. Rust (eds.). Addison-Wesley, (1993):253-83.
- \_\_\_\_\_ and \_\_\_\_\_, "Price Formation in Double Auction Markets." *Journal of Economic Dynamics and Control*, vol. 20 (1996):1307-37.
- \_\_\_\_\_ and \_\_\_\_\_, "Price Formation in Single Call Markets." *Econometrica* 65 (1997):311-45.
- \_\_\_\_\_ and C. R. Plott, "EPA's New Emissions Trading Mechanism: A Laboratory Evaluation." *Journal of Environmental Economics and Management* 30, (1996):133-160.
- Copeland, Thomas and D. Friedman, "The Effect of Sequential Information Arrival on Asset Prices: ." An experimental study. *Journal of Finance* 42 (1987):763-97.
- \_\_\_\_\_ and \_\_\_\_\_, "Partial Revelation of Information in Experimental Asset Markets." *Journal of Finance* 46 (1991):265-95.

\_\_\_\_\_ and \_\_\_\_\_, "The Market Value of Information: Some Experimental Results." *Journal of Business* 65 (1992):241-66.

Davis, D. and A. Williams, "The Effects of Nonstationarities on Performance in Call Markets." *Journal of Economic Behavior and Organization*, 32 (1997): 39-54.

Easley, D. and J. O. Ledyard, "Theories of Price Formation and Exchange in Double Oral Auctions, The Double Auction Market: Institutions, Theories and Evidence," D. Friedman and J. Rust, (eds.). Addison-Wesley, (1993):253-83.

Fiorina, Morris, and C. R. Plott, "Committee Decisions under Majority Rule: An Experimental Study," *American Political Science Review* 72 (June 1978):575-598.

Forsythe, Robert and R. Lundholm, "Information Aggregation in an Experimental Market." *Econometrica* 58 (1990):309-47.

\_\_\_\_\_, T. R. Palfrey, and C. R. Plott, "Asset Valuation in an Experimental Market", *Econometrica*, 50 (May 1982):537-67.

\_\_\_\_\_, \_\_\_\_\_, and \_\_\_\_\_, "Futures Markets and Informational Efficiency: A Laboratory Examination." *The Journal of American Finance Association* 39 (September 1984):955-81.

Friedman, Daniel, "A Simple Testable Model of Double Auction Markets." *Journal of Economic Behavior and Organization* 15 (1991):47-70.

\_\_\_\_\_, "How Trading Institutions Affect Financial Market Performance: Some Laboratory Evidence." *Economic Inquiry*, 31 (July 1993):410-35.

Gjerstad, Steven and J. Dickhaut, "Price Formation in Double Auctions." *Games and Economic Behavior* 22 (1995):1-29.

Gode, Dhananjay K. and S.Sunder, "Allocative Efficiency of Markets with Zero-intelligence Traders: Market as a Partial Substitute for Individual Rationality." *Journal of Political Economy* 101 (1993):119-37.

\_\_\_\_\_ and \_\_\_\_\_, "What Makes Markets Allocatively Efficient." *Quarterly Journal of Economics* 112, 2 (1997):603-30.

Goodfellow, J. and C. R. Plott, "An Experimental Examination of the Simultaneous Determination of Input Prices and Output Prices." *Southern Economics Journal* 56 (1990):969-83.

Hirota, Masayoshi, "On the Stability of Competitive Equilibrium and the Patterns of Initial Holdings: An Example." *International Economic Review* 22(1981):461-7.

Isaac, R. Mark and C. R. Plott, "Price Controls and the Behavior of Auction Markets: An Experimental Examination." *American Economic Review* 71 (June 1981):448-459.

Jamison, J. and C. R. Plott, "Costly Offers and the Equilibration Properties of the Multiple Unit Double Auction Under Conditions of Unpredictable Shifts of Demand and Supply." *Journal of Economic Behavior and Organization* 32 (1997):591-612.

Johnson, Alonzo, H. Y. Lee, and C. R. Plott, "Multiple Unit Double Auction User's Manual," with. Social Science Working Paper no. 676. Pasadena, California Institute of Technology, revised September 1989.

Johnson, Michael D. and C. R. Plott, "The Effect of Two Trading Institutions on Price Expectations and the Stability of Supply-Response Lag Markets." *Journal of Economic Psychology* 10 (1989):189-216.

Kagel, John H. and D. Levin, "The Winner's Curse and Public Information in Common Value Auctions." *American Economic Review* 76 (1986):894-920.

Lei, Vivian, C. N. Noussair, and C. R. Plott, "Non-Speculative Bubbles in Experimental Asset Markets: Lack of Common Knowledge of Rationality vs. Actual Irrationality," with. *Econometrica*, (July, 2001):831-859.

Lian, Peng and C. R. Plott, "General Equilibrium, Markets, Macroeconomics and Money in a Laboratory Experimental Environment." *Economic Theory* 12 #1 (1998):21-75.

Nöth, Markus, and M. Weber, "Insider Detection in Experimental Asset Markets." Working Paper No. 96-05 (1996) Mannheim.

Noussair, Charles N., R. G. Riezman, and C. R. Plott, "An Experimental Investigation of the Patterns of International Trade," with. *American Economic Review*, vol. 85, no. 3 (June 1995):462-91.

\_\_\_\_\_, \_\_\_\_\_, \_\_\_\_\_, "The Principles of Exchange Rate Determination in an International Finance Experiment, with Charles Noussair and Raymond Riezman. *Journal of Political Economy*, vol. 105, #4 (August 1997):822-61.

Plott, Charles R., "The Application of Laboratory Experimental Methods to Public Choice." In *Collective Decision-Making: Applications from Public Choice Theory*, edited by Clifford S. Russell, pp. 137-160. Baltimore, Md.: Johns Hopkins Press for Resources for the Future, 1979.

\_\_\_\_\_, "Research on Pricing in a Gas Transportation Network." Office of Economic Policy Technical Report no. 88-2. Federal Energy Regulatory Commission, Washington, D.C., July 1988.



\_\_\_\_\_, "A Computerized Laboratory Market System and Research Support Systems for the Multiple Unit Double Auction," Social Science Working Paper no. 783. (November 1991), Pasadena: California Institute of Technology.

\_\_\_\_\_, "Market Architectures, Institutional Landscapes and Testbed Experiments." *Economic Theory* 4 (1994):3-10.

\_\_\_\_\_, "Policy and the Use of Laboratory Experimental Methodology in Economics." *Uncertain Decisions Bridging Theory and Experiments*, edited by Luigi Luini. Boston. Kluwer Academic Publishers (1999): 293-315.

\_\_\_\_\_, "Market Stability: Backward Bending Supply in a Laboratory Market." *Economic Inquiry* 38, no. 1 (2000a):1-18.

\_\_\_\_\_, "Markets as Information Gathering Tools." *Southern Economic Journal* (2000b):2-15.

\_\_\_\_\_, *Public Economics, Political Processes and Policy Applications: Collected Papers on the Experimental Foundations of Economics and Political Science*, volume one, Edward Elgar, Cheltenham, U.K., 2001.

\_\_\_\_\_, and G. George, "Marshallian vs. Walrasian Stability in an Experimental Market." *Economic Journal* (May 1992):437-60.

\_\_\_\_\_, and P. Gray, "The Multiple Unit Double Auction." *Journal of Economic Behavior and Organization* 13 (1990):245-58.

\_\_\_\_\_, and David P. Porter, "Market Architectures and Institutional Testbedding: An Experiment with Space Station Pricing Policies". *Journal of Economic Behavior and Organization*, 31(2), (1996):237-72.

\_\_\_\_\_ and J. Smith, "Instability of Equilibria in Experimental Markets: Upward-Sloping Demands, Externalities, and Fad-Like Incentives." *Southern Economic Journal* 65(3), (January 1999):405-426

\_\_\_\_\_ and V. L. Smith, "An Experimental Examination of Two Exchange Institutions. *The Review of Economic Studies*, Vol. XLV (1) (February 1978):133-153.

\_\_\_\_\_ and S. Sunder, "Efficiency of experimental security markets with insider information: An application of rational expectations models." *Journal of Political Economy*, 90 (1982):663-98.

\_\_\_\_\_, and \_\_\_\_\_, "Rational Expectations and the Aggregation of Diverse Information in Laboratory Security Markets." *Econometrica* 56, (1988):1085-1118.

\_\_\_\_\_, and Louis L. Wilde, "Professional Diagnosis vs. Self-Diagnosis: An Experimental Examination of Some Special Features of Markets with Uncertainty." *Research in Experimental Economics*, Vol.2, Vernon L. Smith (ed.), JAI Press, 1982,63-112.

\_\_\_\_\_, J. Wit., and W. C. Yang, "Parimutuel Betting Markets as Information Aggregation Devices: Experimental Results." *Economic Theory*. Forthcoming.

Porter, David P. and V. L. Smith, "Stock Market Bubbles in the Laboratory." *Applied Mathematical Finance* 1, (1994):111-27.

Scarf, Herbert, "Some Examples of Global Instability of the Competitive Equilibrium." *International Economic Review* 1(1960)157-71.

Smith, Vernon L., "An Experimental Study of Competitive Market Behavior." *Journal of Political Economy*, 70, 2 (April 1962):111-37.

\_\_\_\_\_, "Experimental Auction Markets and the Walrasian Hypothesis" *Journal of Political Economy* (August 1965).

\_\_\_\_\_, "Experimental Economics: Induced Value Theory", *American Economic Review*, 66 (1976):274-279.

\_\_\_\_\_, M. van Boening, and C. P. Wellford, "Dividend Timing and Behavior in Laboratory Asset Markets." *Economic Theory* 16, 3(2000):567-83

\_\_\_\_\_, G. Suchanek and A. Williams, "Bubbles, Crashes, and Endogenous Expectations in Experimental Spot Asset Markets." *Econometrica*, 56 (September 1988): 1119-51.

\_\_\_\_\_, A. Williams, W. K. Bratton, and M. G. Vannoni, "Competitive Market Institutions: Double Auctions vs Sealed Bid-Offer Auctions." *American Economic Review* (March 1982).

Sunder, Shyam, "Market for Information: Experimental Evidence." *Econometrica* 160 (1992):667-95

\_\_\_\_\_, "Experimental Asset Markets: A Survey. Handbook of Experimental Economics, J. Kagel and A. E. Roth (eds.). Princeton: Princeton University Press, (1995).

Van Boening, M., A. Williams and S. LaMaster, "Price Bubbles and Crashes in Experimental Call Markets." *Economics Letters*, 41 (1993): 179-85.

Williams, Arlington W., "Computerized Double-Auction Markets: Some Initial Experimental Results," *Journal of Business*, 53, (July 1980):235-258.

\_\_\_\_\_, V. L. Smith, J. O. Ledyard, and S. Gjerstad, "Concurrent Trading in Two Experimental Markets with Demand Interdependence," *Economic Theory*, 16 (November 2000):511-528.

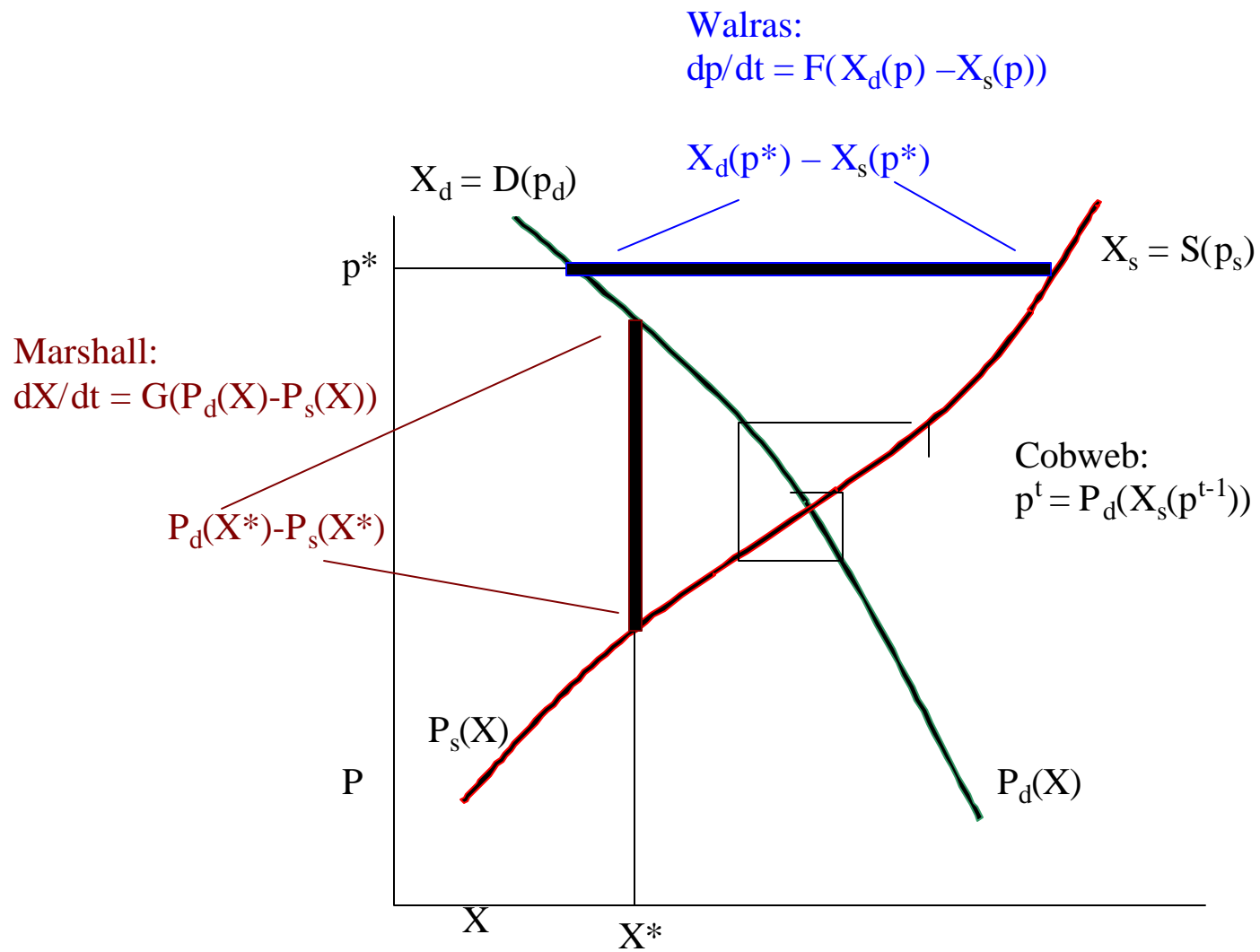

Figure 1: Models of Market

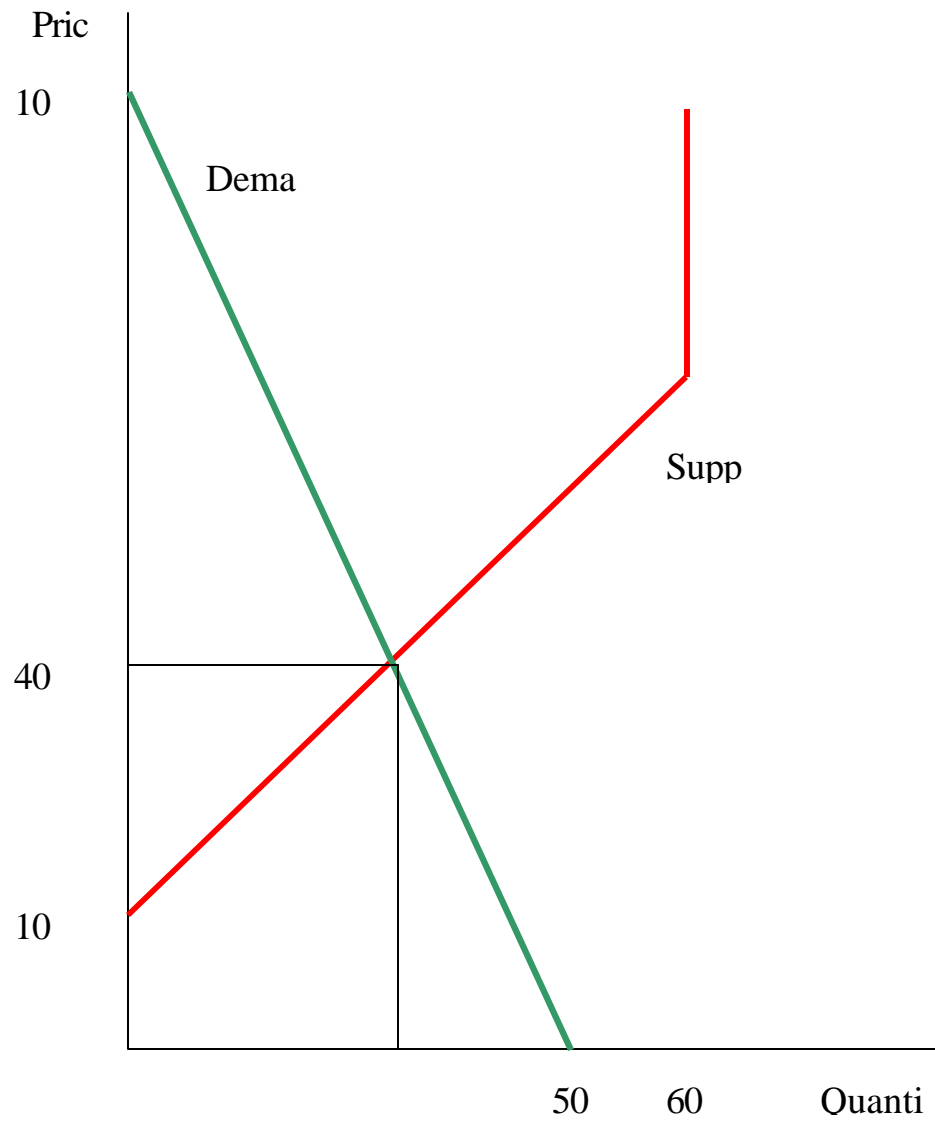

Figure 2. The Demand and Supply Equilibrium of

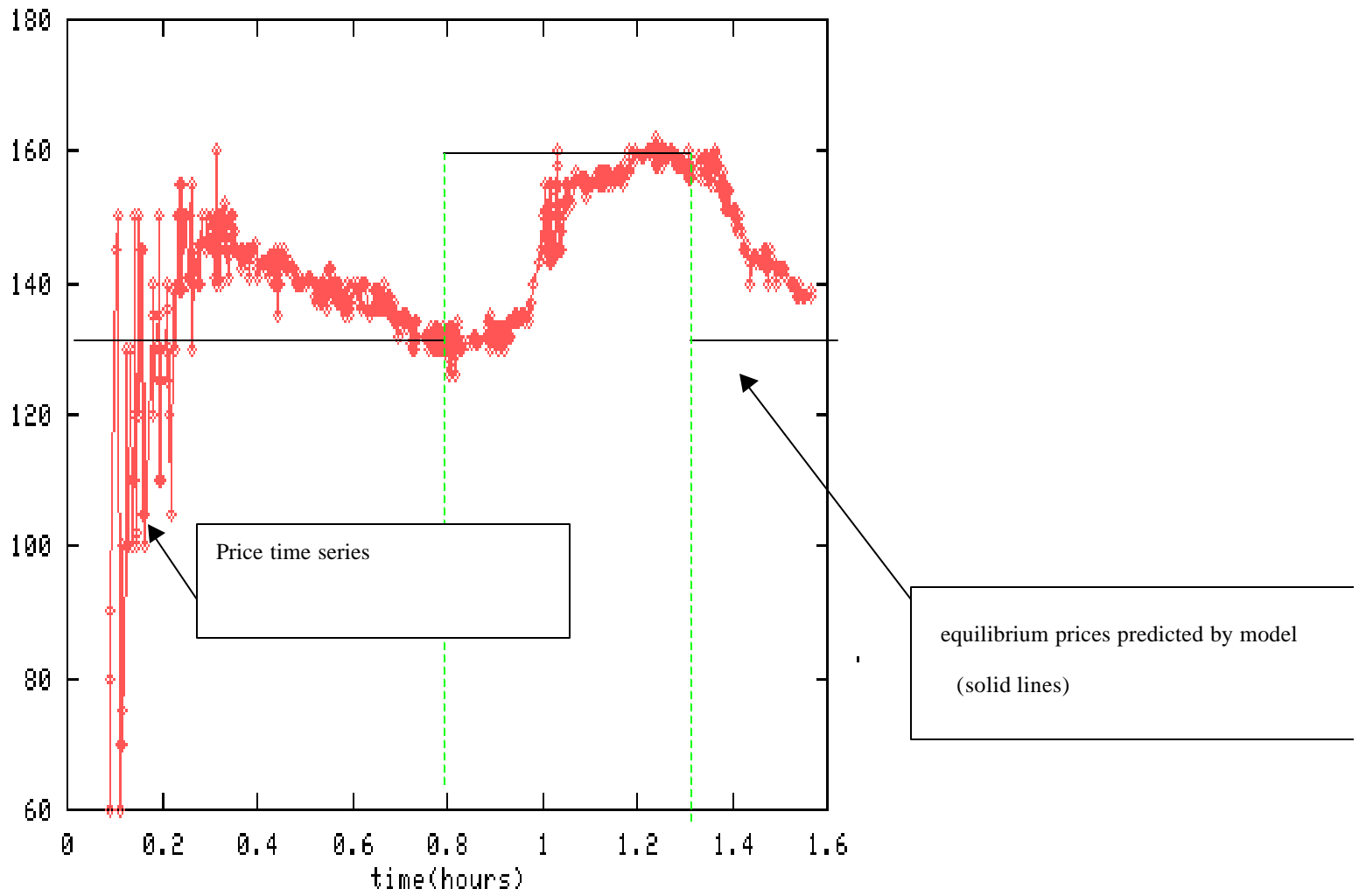
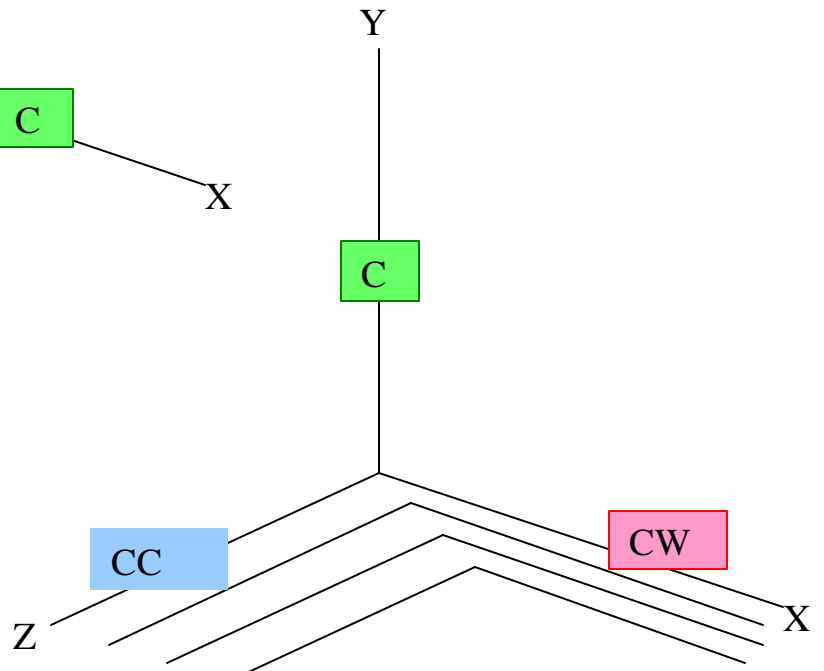
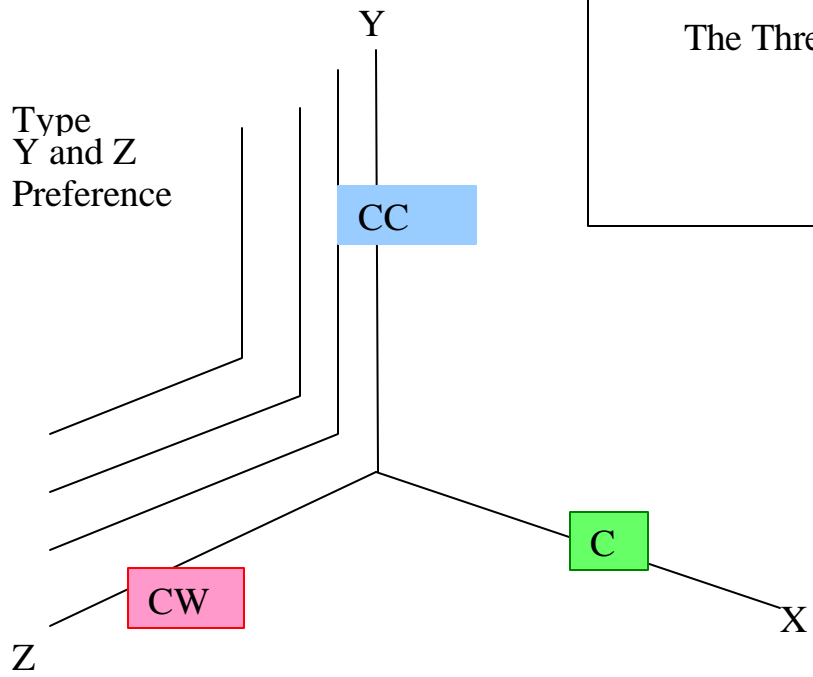
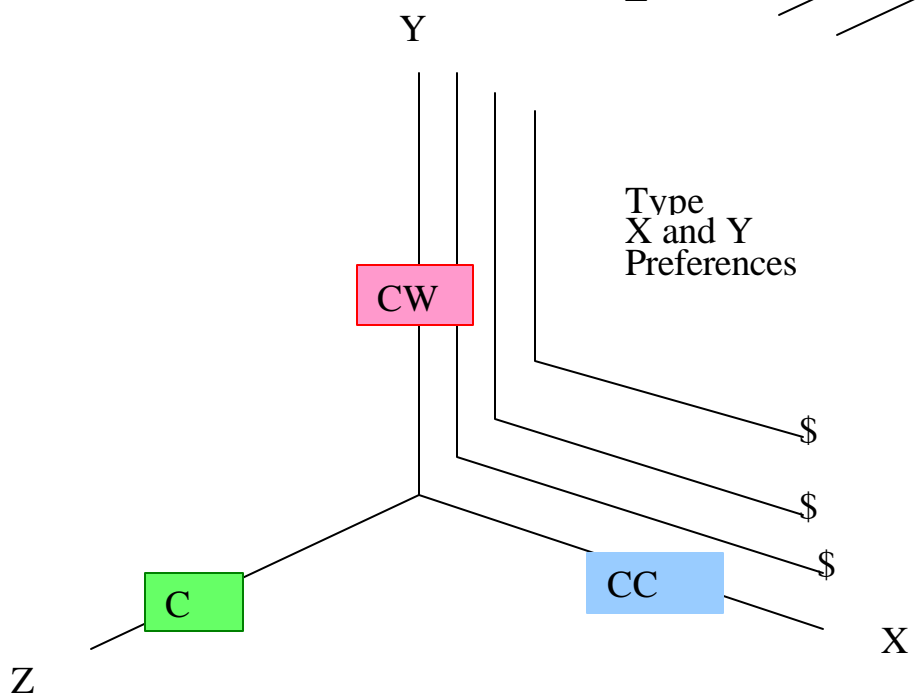

Figure 3: Time Series of Transactions Prices with Parameter Changes

Figure  
The Three Types of Preferences in the



Type X and Z Preferences



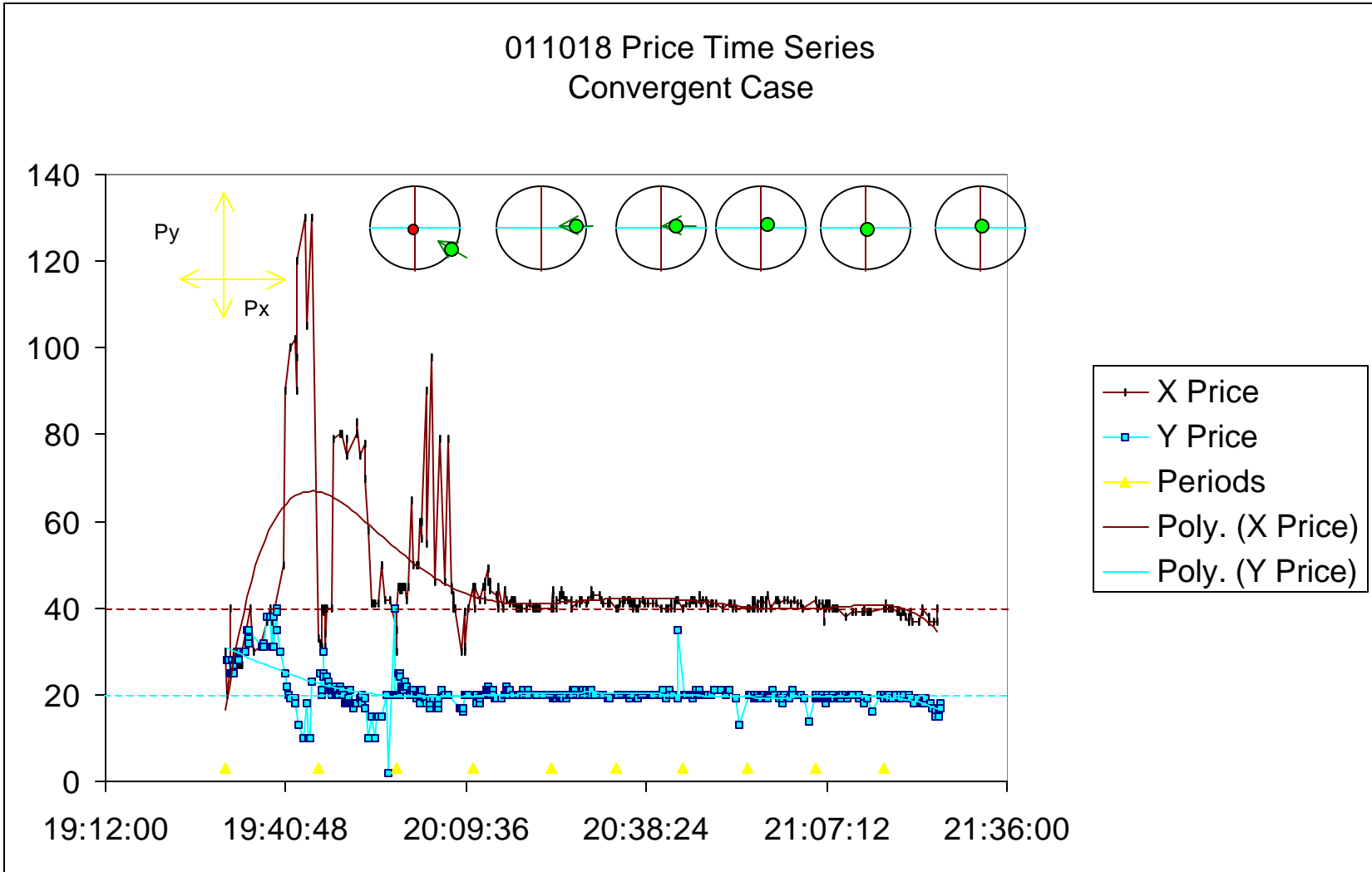

Figure 5: Time Series of Prices in the Scarf Environment When Initial Endowments Are at the Convergent Amounts



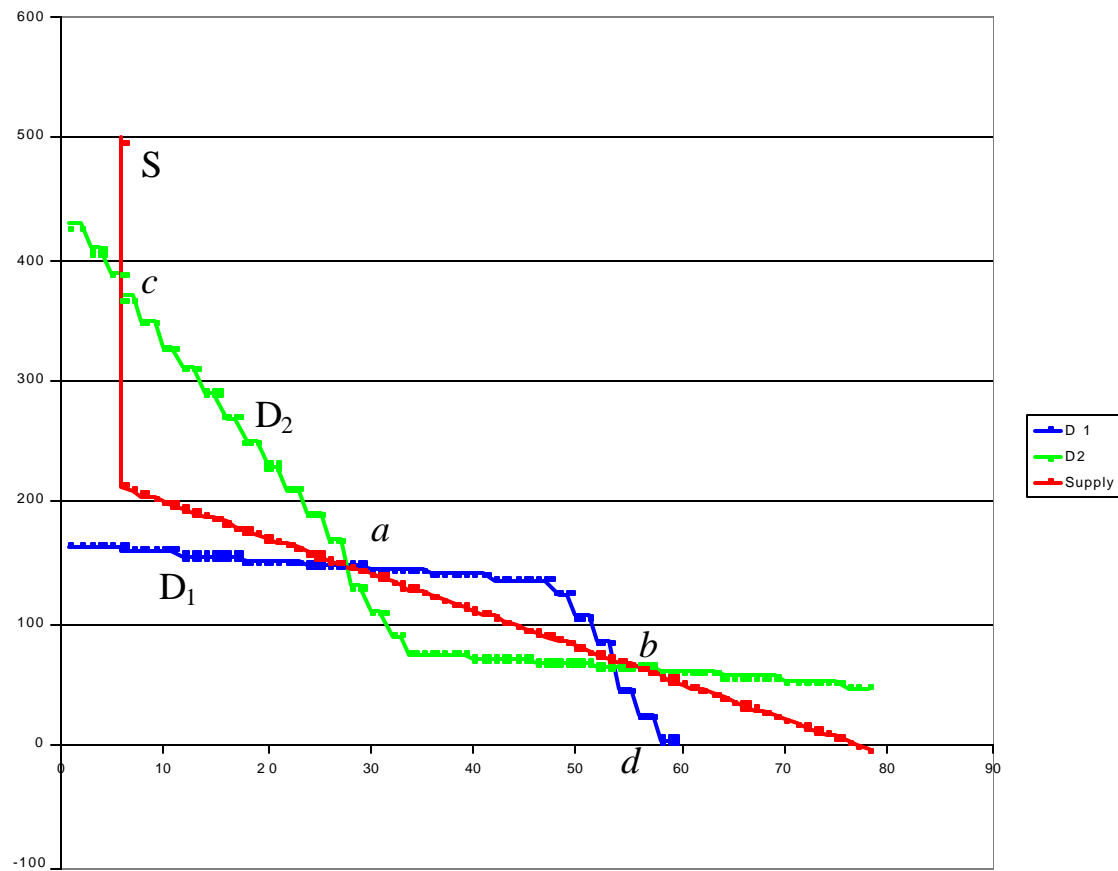

Figure 6: Demand and Supply Parameters Used to Demonstrate Walrasian Stability

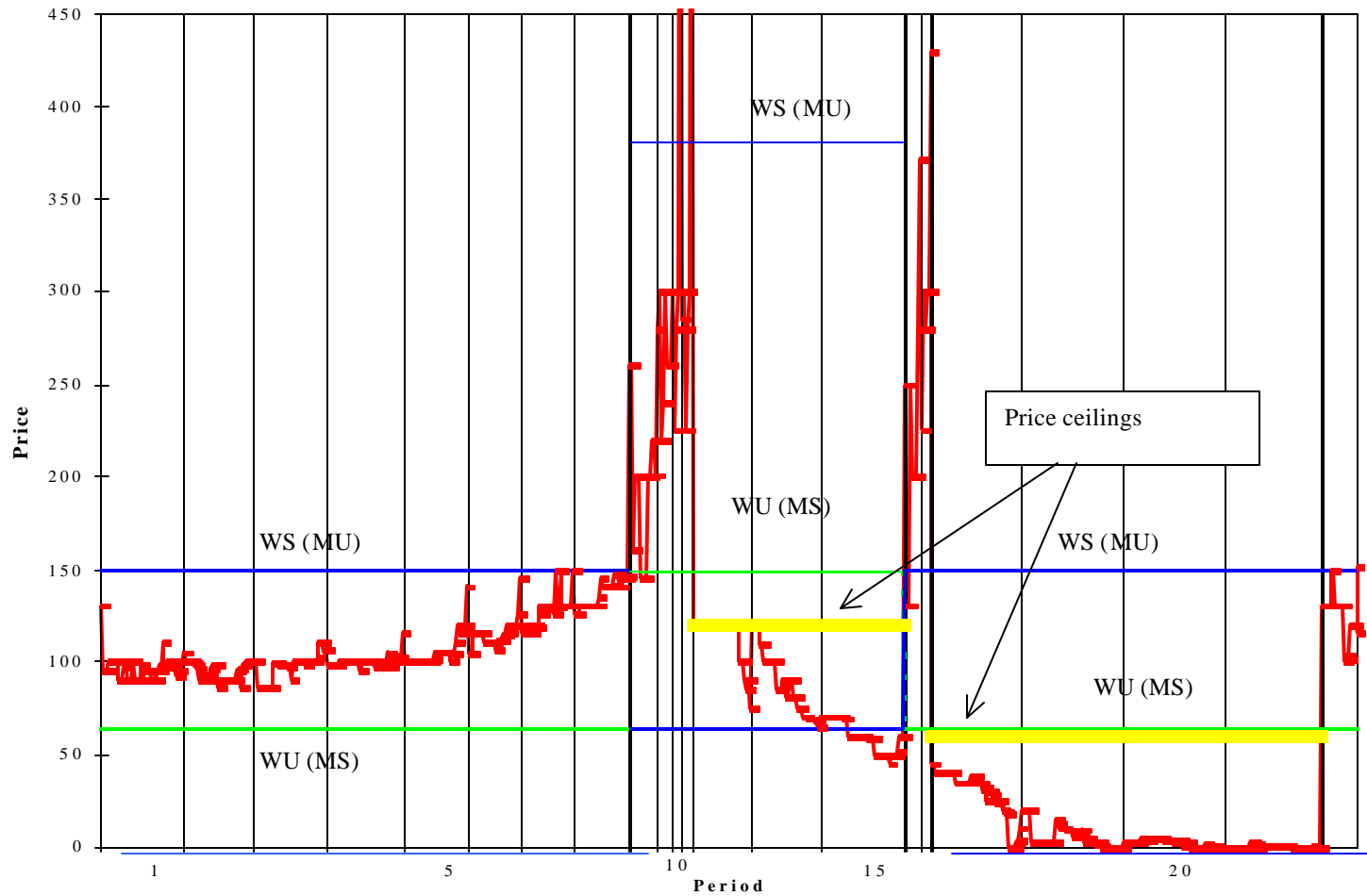

Figure 7: Time Series of Transaction Prices Under Changing Conditions of Demand and Imposition of Price Ceilings

Table 1: Parameters for Scarf Environment Experiments					
Case	type	preferences	initial endowments		
			X	Y	X
Convergence to Equilibrium	I	$40\min\{y/20,z/400\}$	10	0	0
	II	$40\min\{x/10,z/400\}$	0	20	0
	III	$40\min\{x/10,y/20\}$	0	0	400
Counter Clockwise Orbit	I	$40\min\{y/20,z/400\}$	0	20	0
	II	$40\min\{x/10,z/400\}$	0	0	400
	III	$40\min\{x/10,y/20\}$	10	0	0
Clockwise Orbit	I	$40\min\{y/20,z/400\}$	0	0	400
	II	$40\min\{x/10,z/400\}$	10	0	0
	III	$40\min\{x/10,y/20\}$	0	20	0

Figure 8: Typical Orbit Predictions in the X and Y Price Space

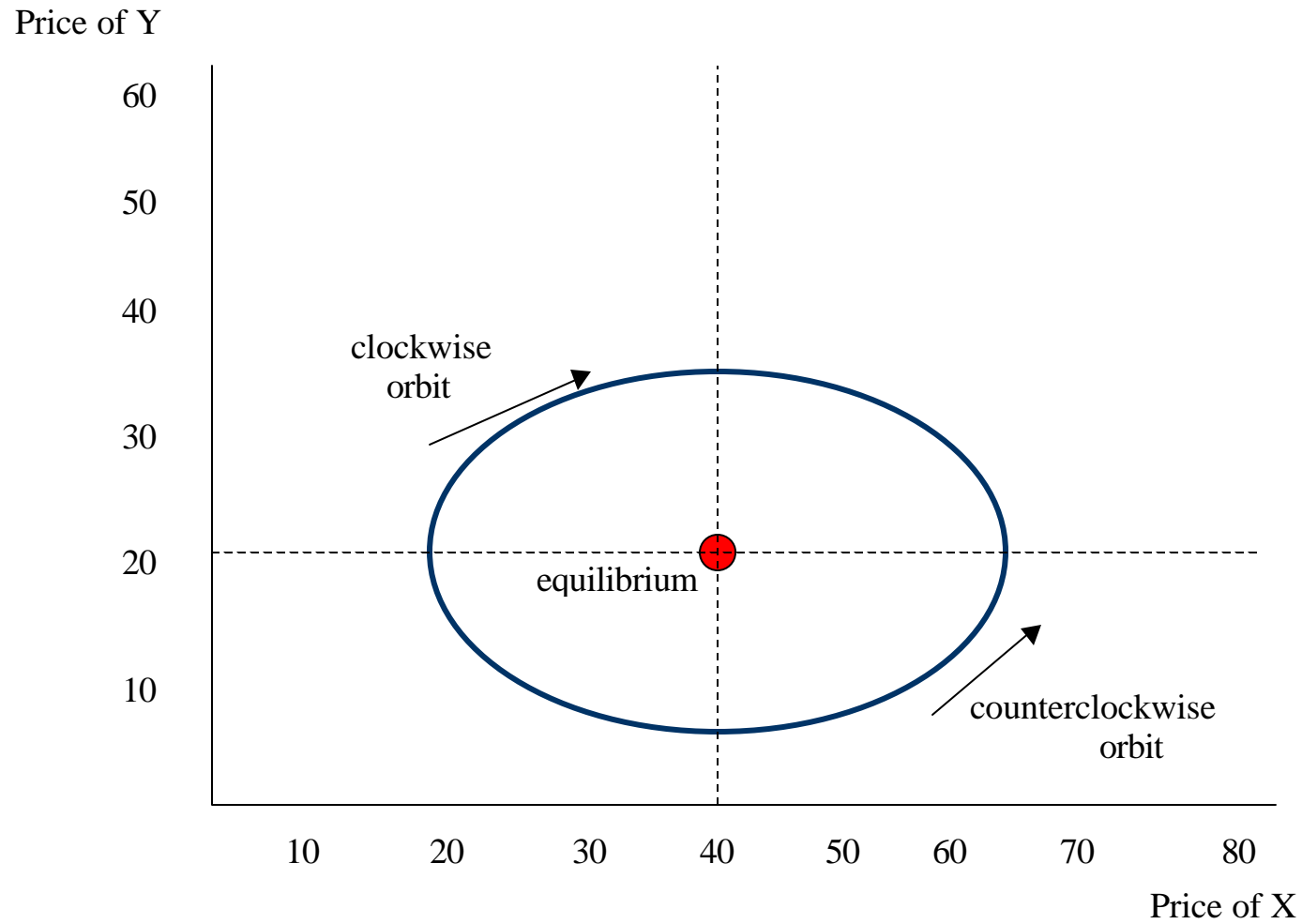
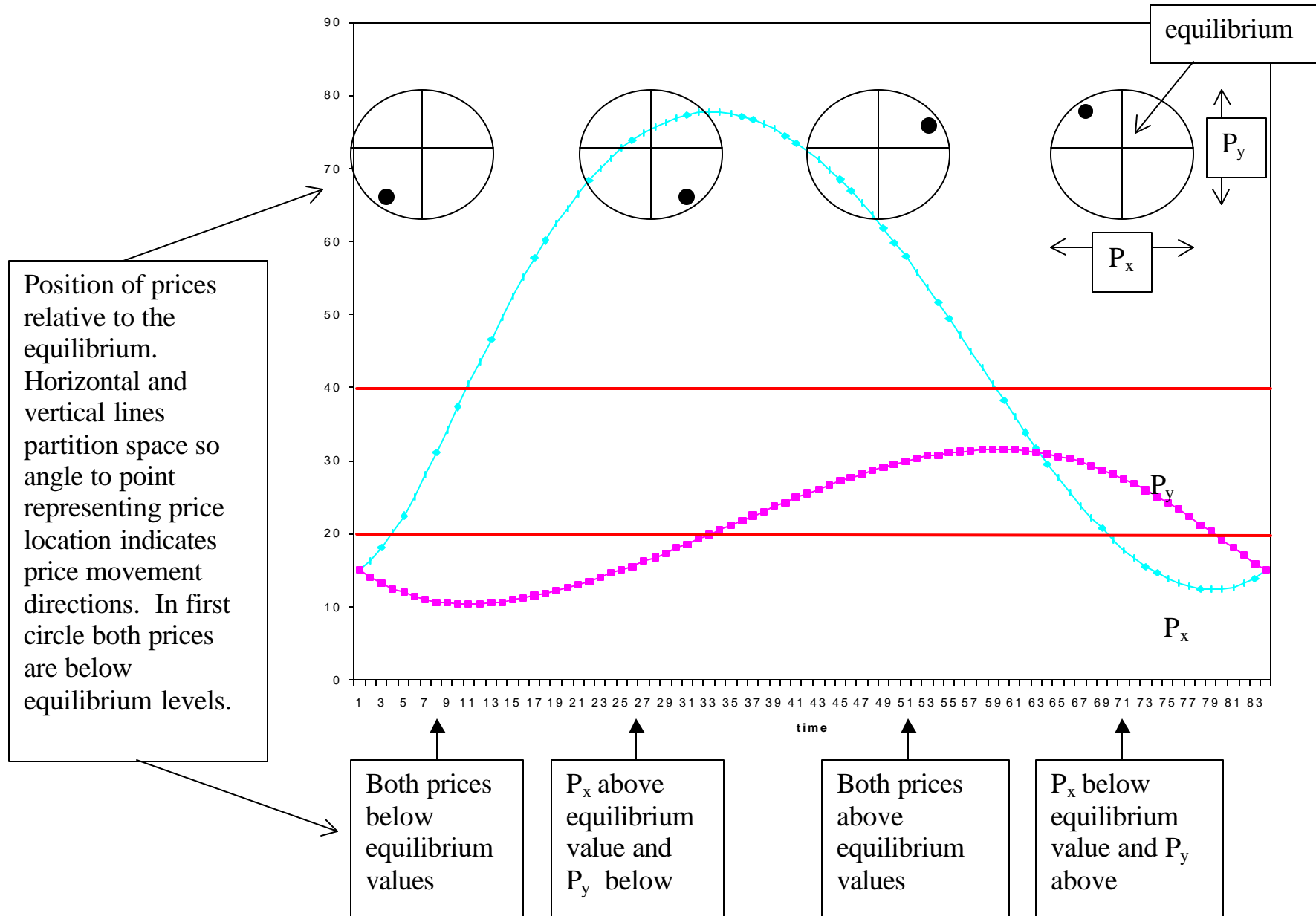

Figure 9 Orbit Model Time Series



# 010120 price time series counterclockwise case

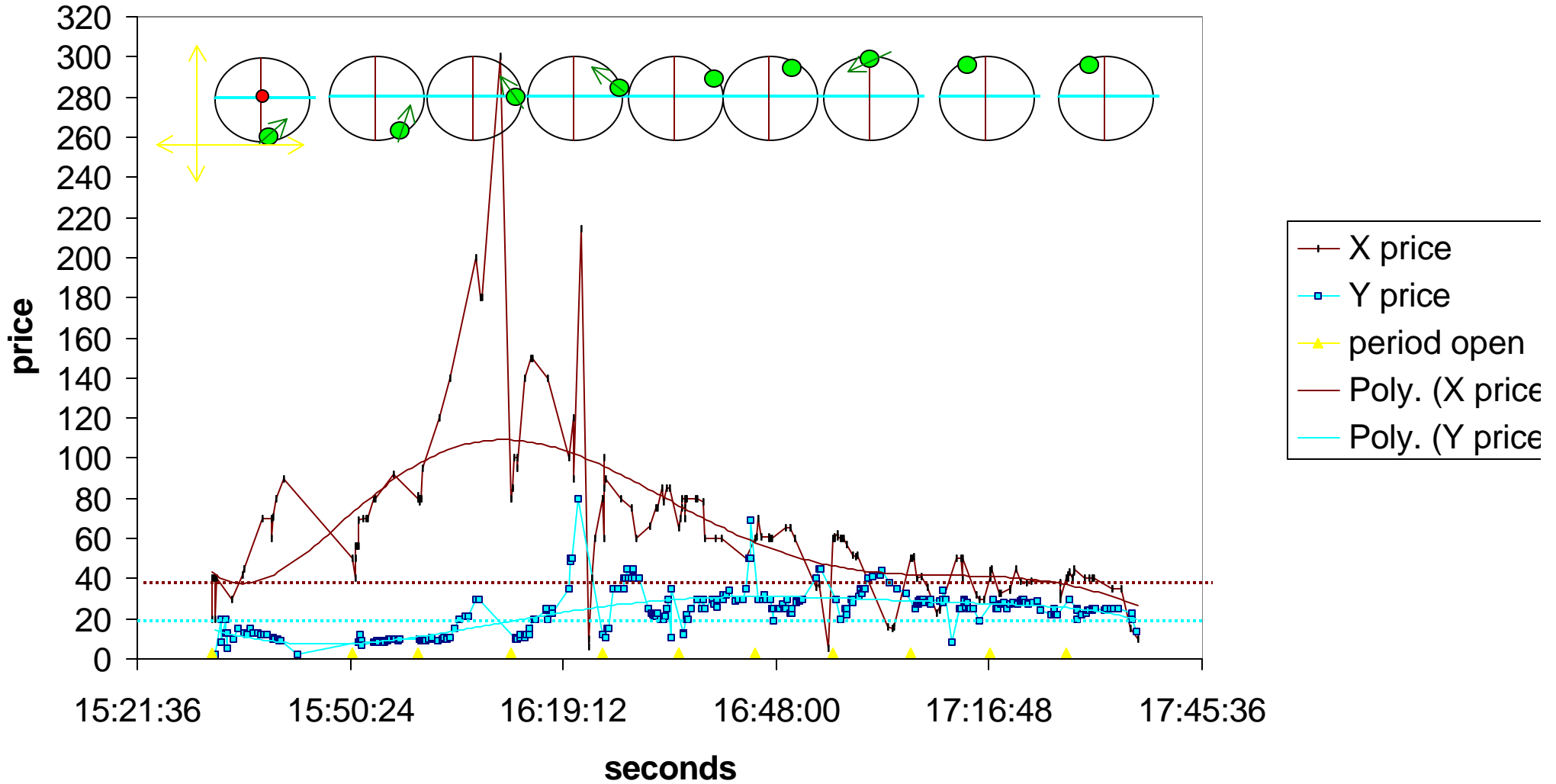

Figure 10A: Price Time Series and Polynomial Approximations of Series

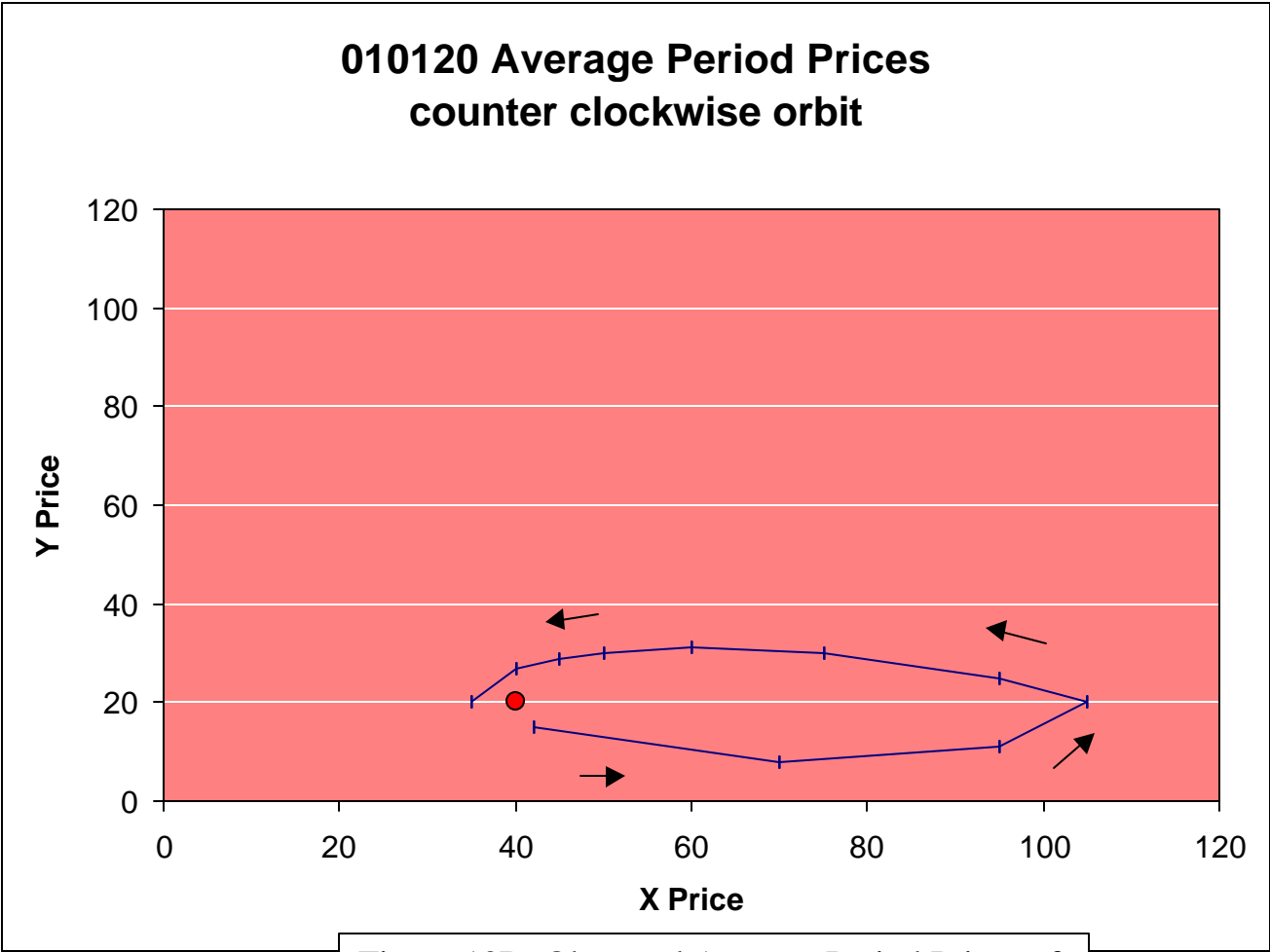

Figure 10B: Observed Average Period Prices of X and Y for all Periods, Counterclockwise Orbit Parameters

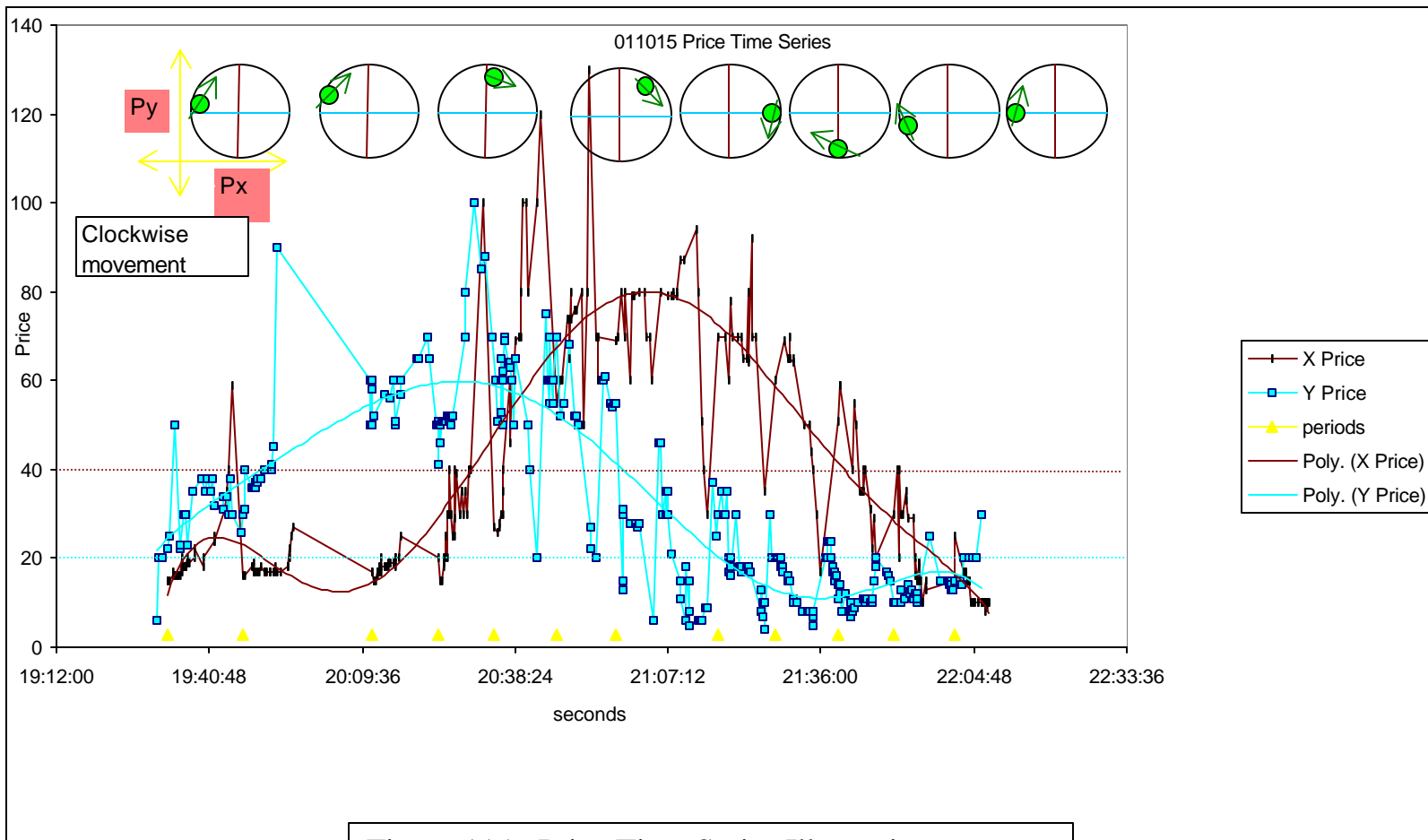

Figure 11A: Price Time Series Illustrating Clockwise Movement and Polynomial Approximations of the Series.



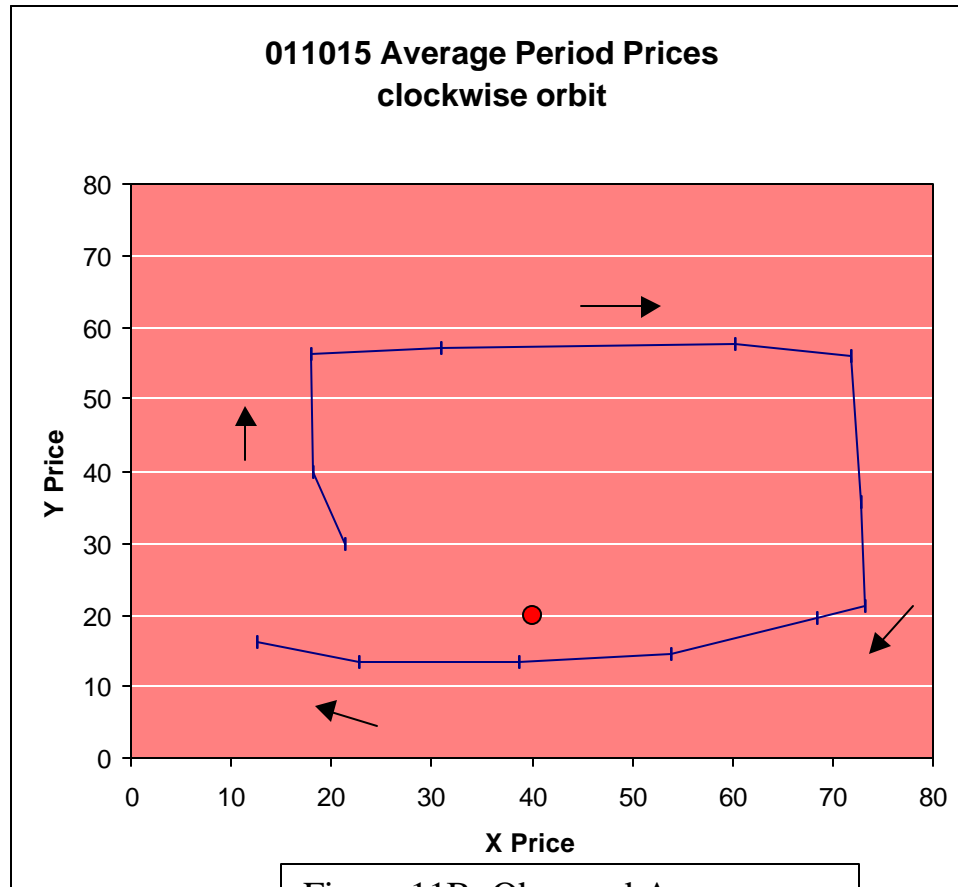

Figure 11B: Observed Average Period Prices of X and Y for all Periods, Clockwise Orbit

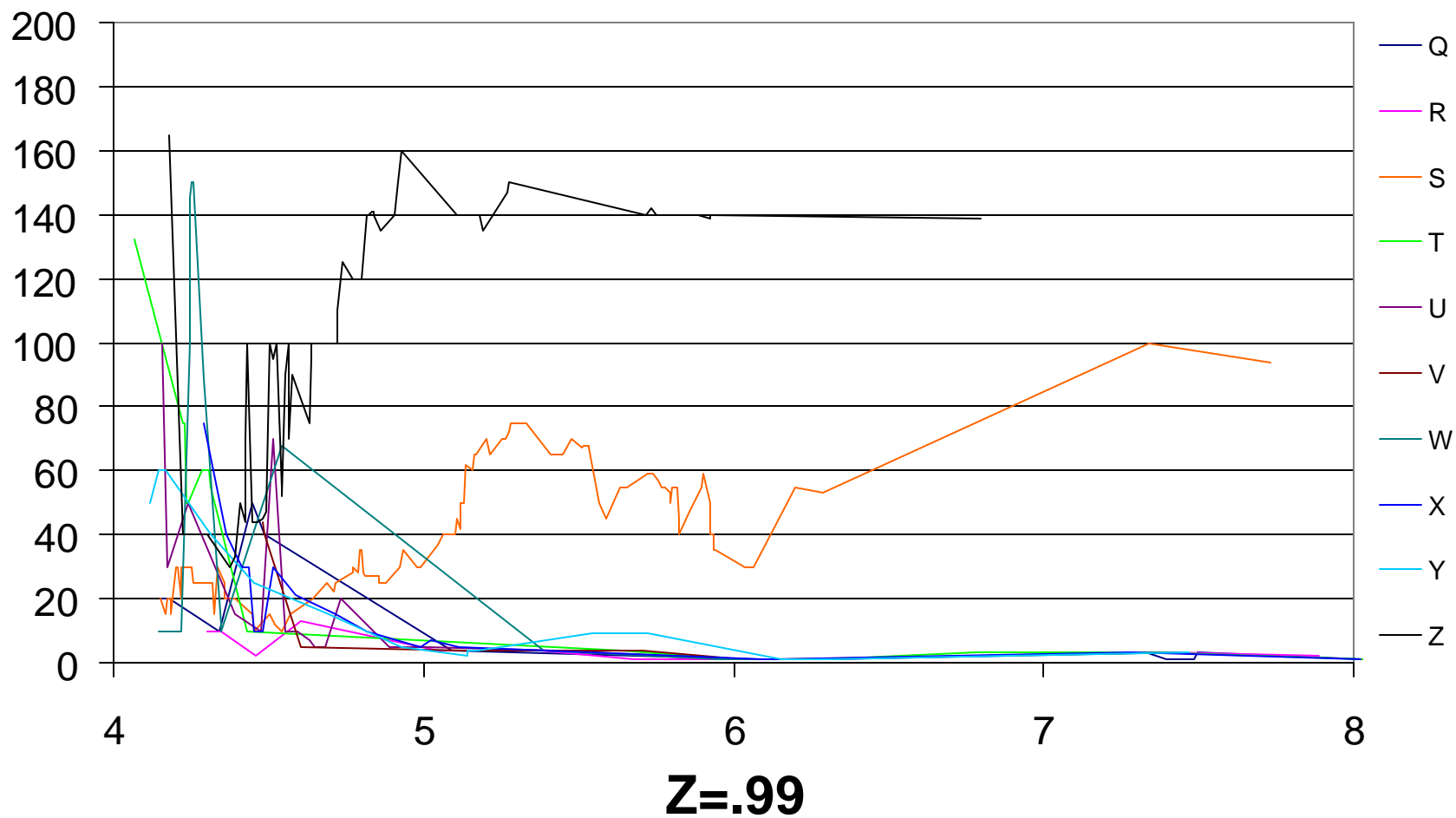

Figure 12A  
 Arrow Debreu markets are able to collect and publish information distributed over many agents:  
 the market of the actual state emerges quickly with highest prices

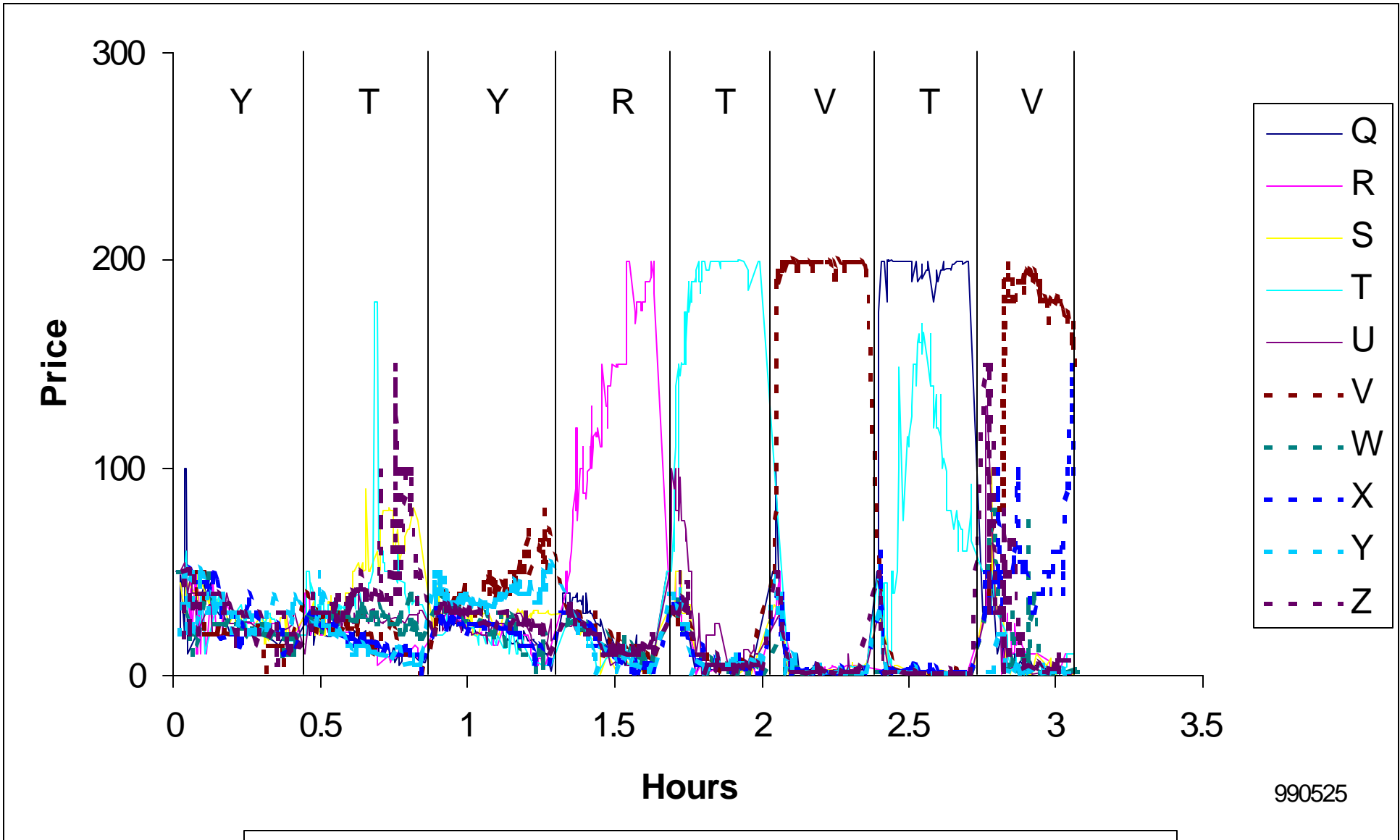

Figure 12 B: Arrow-Debreu Markets: Price Time Series in Ten Markets for Each of Eight Periods. After Three Periods of Experience the True State Emerges Quickly with the Highest Price.

990525

FIGURE 13

**INFORMATION AGGREGATION MARKETS FOR PROBABLE SEPTEMBER SALES OF EQUIPMENT CALLED "LOW"**

Markets (Open 1 <sup>st</sup> week of July)	SEPTEMBER SALES OF "LOW"									
	000	1501	1601	1701	1801	1901	2001	2101	2201	2301
	1500	1600	1700	1800	1900	2000	2100	2200	2300	MORE
SEP-LOW-0000-1500	\$1.00	0	0	0	0	0	0	0	0	0
SEP-LOW-1501-1600	0	\$1.00	0	0	0	0	0	0	0	0
SEP-LOW-1601-1700	0	0	\$1.00	0	0	0	0	0	0	0
SEP-LOW-1701-1800	0	0	0	\$1.00	0	0	0	0	0	0
SEP-LOW-1801-1900	0	0	0	0	\$1.00	0	0	0	0	0
SEP-LOW-1901- 2000	0	0	0	0	0	\$1.00	0	0	0	0
SEP-LOW-2001- 2100	0	0	0	0	0	0	\$1.00	0	0	0
SEP-LOW-2101- 2200	0	0	0	0	0	0	0	\$1.00	0	0
SEP-LOW-2201-2300	0	0	0	0	0	0	0	0	\$1.00	0
SEP-LOW-2301- MORE	0	0	0	0	0	0	0	0	0	\$1.00

FIGURE 14

Markets are Closed until October, see the [Announcements](#).

**MARKET SUMMARY**    **September Low Markets**    **ID: 1 Wed Apr 28 18:15:25 1999**    [RELOAD](#)

Please Select Markets:    [September-Low](#)    [All](#)

	Your	Best Buy	Best Sell	Last	My	My			Order Form
	Market	Shares	Offer	Offer	Trade	Offers	Trades	Graph	History
<a href="#">SEP-LOW-0000-1500</a>	0	10@7	5@9	9	-/-	●	●	●	●
<a href="#">SEP-LOW-1501-1600</a>	0	5@10	20@24	10	-/-	●	●	●	●
<a href="#">SEP-LOW-1601-1700</a>	0	5@14	10@25	14	-/-	●	●	●	●
<a href="#">SEP-LOW-1701-1800</a>	0	5@11	10@30	11	-/-	●	●	●	●
<a href="#">SEP-LOW-1801-1900</a>	0	20@7	10@39	11	-/-	●	●	●	●
<a href="#">SEP-LOW-1901-2000</a>	0	5@22	10@28	22	-/-	●	●	●	●
<a href="#">SEP-LOW-2001-2100</a>	0	10@11	10@45	18	-/-	●	●	●	●
<a href="#">SEP-LOW-2101-2200</a>	0	10@10	10@30	15	-/-	●	●	●	●
<a href="#">SEP-LOW-2201-2300</a>	0	8@5	2@14	14	-/-	●	●	●	●
<a href="#">SEP-LOW-2301-more</a>	0	7@1	10@17	1	-/-	●	●	●	●

Order Form

Buy    Sell

Market:

Units:    Price:

Time to Expire:  (e.g. 1h6m5s; 0=never expire)

Your cash on hand is: **0**    [Home](#)   [Instructions and Help](#)   [Announcements, Last Sep 11, 10:00 AM](#)    [LOGOUT](#)

[HP Schedules and Tips](#)   [HP Data](#)   [Advanced Orders](#)   [Graph of All September Low Markets](#)   [Inventory](#)   [Personal Trade History](#)