

# AIAA'87

**AIAA-87-0111**

**Vortical Patterns in the Wake of an  
Oscillating Airfoil**

M. M. Koochesfahani, California  
Institute of Technology, Pasadena, CA

**AIAA 25th Aerospace Sciences Meeting**

January 12-15, 1987/Reno, Nevada

M. M. Koochesfahani\*

California Institute of Technology  
Pasadena, California

**Abstract**

The vortical flow patterns in the wake of a NACA 0012 airfoil pitching at small amplitudes are studied in a low speed water channel. It is shown that a great deal of control can be exercised on the structure of the wake by the control of the frequency, amplitude and also the shape of the oscillation waveform. An important observation in this study has been the existence of an axial flow along the cores of the wake vortices. Estimates of the magnitude of the axial flow suggest a linear dependence on the oscillation frequency and amplitude.

**Introduction**

The classical unsteady aerodynamic theory of oscillating airfoils<sup>1,2</sup> was developed as a result of interest in aircraft flutter problem. This theory later found extensive use in biofluidynamics since the propulsion of certain species of birds, insects and aquatic animals is characterized by a heaving and pitching motion of a high aspect ratio wing or fin<sup>3,4</sup>. The main ingredients of the classical analysis are the two-dimensional potential flow along with linearized boundary conditions, small perturbation velocities and the assumption of a planar vortex wake. The effects of non-linear processes such as rolled-up wake patterns have been addressed using numerical techniques<sup>5-7</sup>.

In comparison with the many theoretical and numerical studies that have been devoted to the subject of oscillating airfoils, there appear to be quite few experimental results available. Among the available experimental investigations, most have concentrated on measuring the forces on oscillating wings<sup>8-10</sup>, while studying the characteristics of the wake seems to have received lesser attention. Bratt's<sup>11</sup> smoke flow visualization of the vorticity roll-up in the wake of a wing performing rolling oscillation is one of the earliest works on wake flow patterns and has been used for verification of the numerical techniques mentioned above.

Sinusoidal oscillation of an airfoil has been the traditional form of periodic oscillation studied theoretically, numerically and experimentally. In the present work, the effect of both sinusoidal and nonsinusoidal shape of the waveform on the vortical patterns in the wake of a pitching airfoil is investigated. Qualitative features are determined from flow visualization pictures. Laser Doppler velocimetry is utilized to obtain quantitative measurements of the mean streamwise velocity component. Using the velocity profiles, the dependence of the airfoil drag/thrust on the oscillation amplitude and frequency is determined. The existence of an axial flow along the cores of the wake vortices is pointed out. Its origin and dependence on the oscillation amplitude and frequency are discussed.

**Experimental Facility & Instrumentation**

These experiments were performed in the Low Speed Water Channel of the Graduate Aeronautical Laboratories of California Institute of Technology (GALCIT). The airfoil was based on the NACA 0012 wing section with a chord of  $C = 8$  cm, a span of  $b = 39$  cm and was pivoted about the 1/4-chord point. The airfoil was fitted with end plates since, due to mechanical linkage requirements, the span was smaller than the channel width (45 cm). A shaker coil mechanism in conjunction with a closed-loop feedback servosystem drove the airfoil to the desired angular position in pitch (see figure 1). With this setup, the airfoil angular position followed a command signal which, for these measurements, originated from a function generator (HP3314A). The mean angle of attack, the amplitude  $A$ , the frequency  $f$ , and the shape of the oscillation waveform could, in this way, be independently controlled.

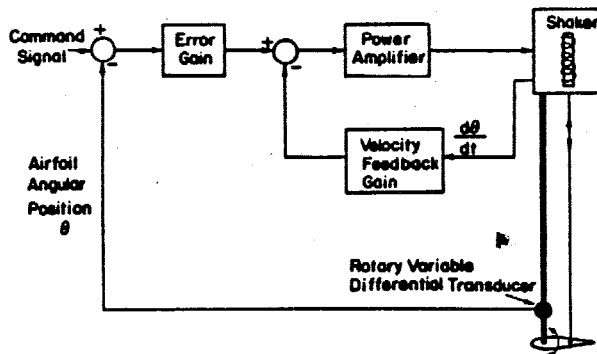

Fig. 1 Schematic of servosystem for control of airfoil angular position.

\* Present address: Department of Mechanical Engineering, Michigan State University, East Lansing, MI 48824. Member AIAA.

The effect of nonsinusoidal oscillation is demonstrated in terms of a symmetry parameter,  $S$ , which is the percentage of a period (in one cycle) required to reach the maximum amplitude starting from the minimum amplitude. When  $S=50\%$  the waveform is sinusoidal whereas a value of  $S$  larger (smaller) than  $50\%$  corresponds to a slower (faster) rate of pitch-up than pitch-down. See figure 2 for sample waveform shapes.

The wake flow was visualized using food-coloring issued from small injection tubes imbedded in the airfoil trailing edge and was subsequently recorded on photographic film by a 35 mm camera. The streamwise component of the velocity vector was measured by a single-channel, frequency-shifted laser Doppler velocimeter (LDV) in the dual scatter mode. The Doppler burst was processed by a Tracking Phase-Locked Loop (in-house design by P.E. Dimotakis) whose output frequency was measured by a Real Time Clock card interfaced to a PDP-11/73 computer.

### Results & Discussion

For the results reported here, the free-stream velocity was approximately  $U_\infty = 15$  cm/sec, resulting in a chord Reynolds number of 12,000 and a reduced frequency of  $k = 2\pi f C / 2U_\infty = 1.67$  (f/Hz). The mean angle of attack was set to zero so that the angle of attack of the airfoil varied between  $-A$  &  $A$ ,  $A$  being the amplitude of pitch waveform.

#### Sinusoidal Oscillation

The sequence of pictures in figure 3 shows the dependence of the wake structure on the oscillation frequency for a sinusoidal ( $S=50\%$ ) pitch waveform. The flow is from right to left and the downstream distance visible on the photographs corresponds to approximately 3.75 chord lengths. It can be seen that, at low frequencies, a smoothly undulating wake is formed which carries the Karman vortices shed by the natural wake. At higher values of the frequency, the wake displays characteristic vortex patterns similar to those observed by Bratt<sup>11</sup> and Thomas & Whiffen<sup>12</sup>. Numerical calculations of Katz & Weihs<sup>13</sup> have suggested a value for the critical reduced frequency,  $k > 2$ , above which the wake rolls up into vortex structures. Even though this value agrees with the data of figure 3, caution should be exercised in this comparison. We have generally observed that the frequency for vortex roll-up decreases as the oscillation amplitude increases. One would expect a similar behavior to exist in numerical calculations. Therefore, the use of a universal critical reduced frequency does not seem to have much significance.

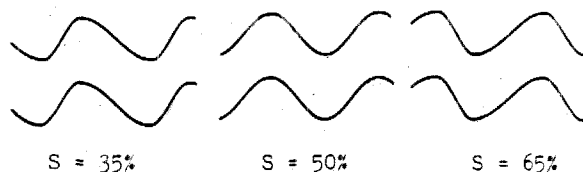
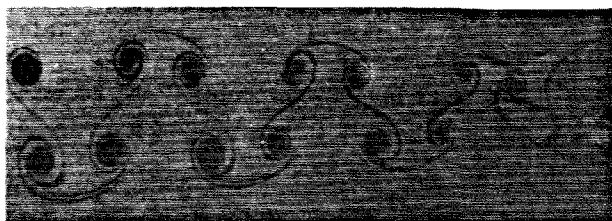

Fig. 2 Examples of pitch waveforms  
Upper trace : airfoil angular position  
Lower trace : command signal.



(a)  $A = 4$  deg.,  $f = 0.5$  Hz



(b)  $A = 4$  deg.,  $f = 1.85$  Hz



(c)  $A = 2$  deg.,  $f = 4.0$  Hz



(d)  $A = 2$  deg.,  $f = 5.0$  Hz



(e)  $A = 2$  deg.,  $f = 6.0$  Hz

Fig. 3 Wake of a NACA 0012 airfoil pitching sinusoidally about  $1/4$ -chord point. Flow is from right to left.

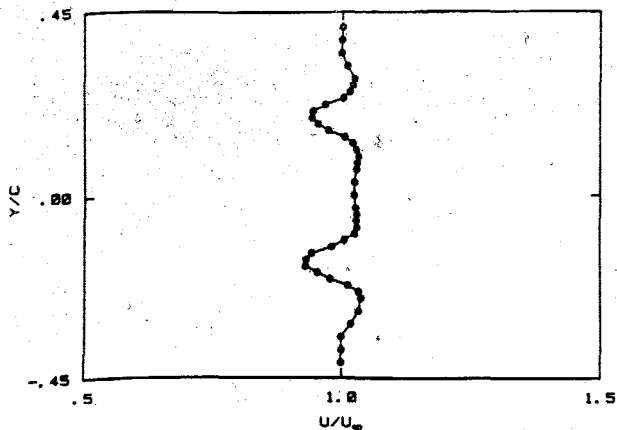

Fig. 4 Mean velocity profile at  $X/C = 1$  for the case in figure 3(b).

Figure 3(b) shows a special case where two vortices of the *same* sign are shed on each half-cycle of the oscillation. The mean velocity profile for this case, figure 4, shows that this vortex pattern corresponds to a double-wake structure. The pattern remained stable (i.e. fixed pattern) all the way to the farthest downstream distance ( $X/C = 30$ ) at which the wake was observed. A similar stable configuration could not be sustained at low amplitudes (e.g. less than 2 degrees). At higher amplitudes, it was possible to generate a stable pattern consisting of three same-sign vortices shed per half-cycle of the oscillation.

Once the frequency is high enough, an alternating vortex pattern is formed such that the vortex with a positive (counter-clockwise) circulation is located on top and the one with negative circulation on the bottom, see figure 3(d,e). This arrangement is opposite that of a typical Karman vortex street observed in wakes and, in fact, this pattern corresponds to a "jet". The mean velocity profiles measured at  $X/C = 1$ , shown in figure 5, also confirm this behavior. In this figure, it can be seen that the usual wake profile with velocity deficit (i.e. an airfoil with drag) can be transformed into a wake with velocity excess (no longer a wake but actually a jet, i.e. an airfoil with thrust) above a certain frequency. It should be noted that the jet-like vortex pattern corresponding to a thrust-generating body is a well-known phenomenon and was described by Von Karman & Burgers<sup>14</sup> for the case of a flat plate in transverse oscillation.

Figure 5 also shows that there exists a condition ( $A=2$  degrees,  $f=4$  Hz) at which the wake has no momentum deficit or excess (i.e. an airfoil with no drag). This condition occurs when

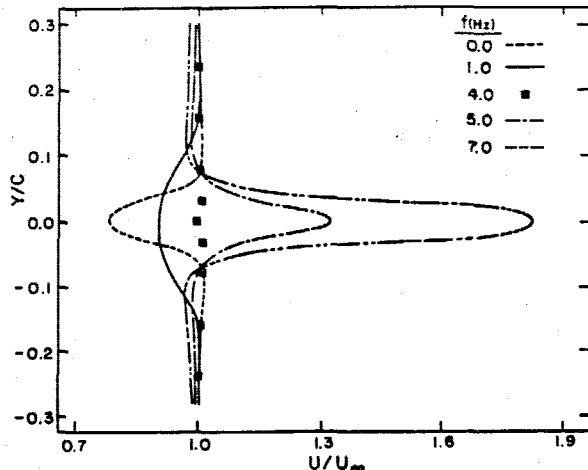

Fig. 5 Mean velocity profiles in the wake of a sinusoidally pitching NACA 0012 airfoil ( $X/C = 1$ ).

the alternating vortices are positioned exactly on a straight line as seen in figure 3(c). The vortex pattern showed no tendency to deviate from this alignment as it moved downstream. As a result of this, the mean velocity profile,  $U$ , measured at  $X/C = 3$  (not show here) was also approximately uniform at the free-stream value much the same way as at  $X/C = 1$  (see figure 5). Note that this implies that the gradients of  $U$  in both streamwise and transverse directions are nearly zero for this special case.

The mean velocity profile  $U(y)$  can be used to estimate the mean streamwise force on the airfoil. With the usual normalization of the force with the free-stream dynamic head and the airfoil chord, the force coefficient is given by

$$C_F = \frac{2}{C} \int_{-\infty}^{\infty} \frac{U}{U_{\infty}} \left( \frac{U}{U_{\infty}} - 1 \right) dy ,$$

where the contributions due to the fluctuating quantities and the pressure term have been neglected. A negative value of  $C_F$  corresponds to drag and a positive value implies thrust. A plot of  $C_F$  versus reduced frequency is shown in figure 6 for two oscillation amplitudes of two and four degrees. The classical theory<sup>15</sup> indicates that the inviscid oscillation of a flat plate around the 1/4-chord point starts producing thrust at a critical reduced frequency of about  $k = 1$ . We note, however, that in the present experiment thrust is produced at a higher reduced frequency. This discrepancy may be expected since here there is a substantial viscous drag to be overcome, which does not of course exist in the inviscid case. Also, within the linear assumptions of the theory, the oscillation amplitude does not affect the predicted critical value of  $k$ , in disagreement with the data of figure 6. Even though one might

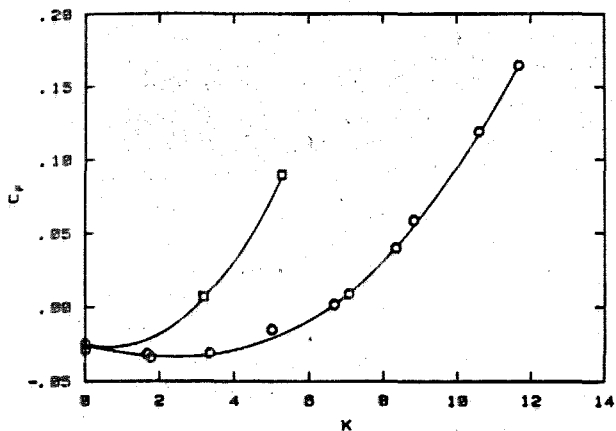

Fig. 6 Variation of force coefficient with reduced frequency.

○ A = 2 deg., □ A = 4 deg.

be tempted to interpret the observed effect of the amplitude as a truly nonlinear effect, other difficulties complicate the issue. Before any comparison between the present low Reynolds number case and inviscid calculations can be attempted, it may be necessary that the oscillation amplitude be "reasonably" large compared to, say, the boundary layer thickness at the airfoil trailing edge. In support of this, it should be mentioned that when the oscillation amplitude was reduced to one degree, no evidence of thrust was found up to  $k = 11$ . Conversely, the amplitude cannot become "too" large if a comparison with a linear theory is to be sensible. It is not presently clear at what amplitude a fair comparison between this experiment and inviscid theory should be made.

Nonsinusoidal Oscillation

The shape of the pitch waveform has a strong effect on the vortical patterns in the wake as demonstrated in figure 7. At a given frequency, by simply changing the shape of the waveform, it is possible to generate a variety of complex vortex-vortex interactions. The general observation is that a single strong vortex is formed during the fast part of the cycle, whereas more than one vortex (of the same sign) form on the slow cycle. For example, in figure 7(a), two vortices of the same sign are shed during the slow cycle. The number of vortices shed during the slow cycle increases with the oscillation amplitude as can be seen in figure 7(b). Note, in this figure, how the pairing events are modified and delayed as the waveform shape changes slightly. It is known that the motion of more than three point vortices is sensitive to the initial conditions and could result in chaotic motions (see Aref<sup>16</sup>). The strong dependence of the wake vortex pattern on the initial conditions which are observed here may be a related



S = 61%



S = 38%

(a) A = 2 deg., f = 4.0 Hz

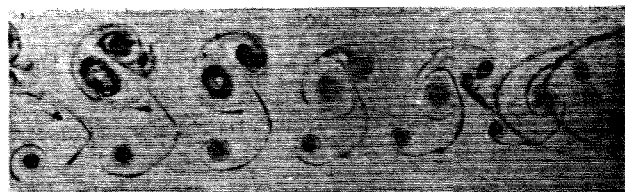

S = 61%



S = 63%



S = 65%

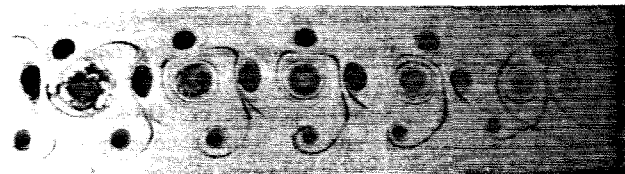

S = 67%

(b) A = 4 deg., f = 3.0 Hz

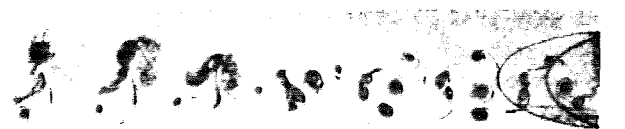

(c) A = 4 deg., f = 3.0 Hz, S = 30%

Fig. 7 Wake patterns for nonsinusoidal oscillation waveform.

phenomenon. Figure 7(c) shows a particularly interesting case where a single vortex on top goes through the wake and ends up on the bottom unscathed.

These modifications of the wake structure occur as a result of the manipulation of the strength (circulation) and spacing of the vortices shed into the wake, which subsequently convect and interact by inviscid vortex interactions. To the extent that these vortices are the carriers of momentum and energy in the wake, the load history on the airfoil may be expected to be strongly affected. Figure 8 shows an example of the extent of the wake modification as displayed by the mean velocity profile measured for the case  $S=38\%$  of figure 7(a). It can be seen that in the same "wake" both wake and jet structures are present. This peculiar behavior becomes readily apparent upon inspection of the arrangement of the vortices for this case (see the close-up accompanying figure 8).

#### Axial Flow along Vortex Cores

The wake is generated here by two-dimensional motions of a geometrically two-dimensional body. The resulting flow, however, is not two-dimensional and an axial flow exists along the cores of the wake vortices, see figure 9. The four dye streaks in this plan view of the wake were placed roughly symmetrically with respect to the water channel centerline and were approximately one chord length apart. The axial flow takes the form of a spiralling out of the vortex core fluid away from the channel side walls toward the channel centerline. Evidence of this type of flow three-dimensionality can also be found in the flow visualization pictures of Cornish<sup>17</sup> and in the rolling wing experiment of Bratt<sup>11</sup> where he states that "vortices were seen to be spiralling out in a spanwise direction from root to tip".

The magnitude of the axial flow appears to depend on both the frequency and amplitude of oscillation and is believed to be tied directly to the vortex circulation. For example, figure 9 shows the increase of the axial velocity when the frequency is increased. This is manifested by the shortening of the distance downstream of the airfoil trailing edge where the axial flow in the vortices reaches the channel centerline. The dependence of this distance, denoted by  $L$ , on the oscillation frequency was derived from plan view photographs and is shown in figure 10. An estimate of the average axial flow velocity,  $W$ , along the vortex cores is presented in figure 11. The values of  $W$  were calculated from the  $L/C$  data of figure 10 assuming a constant axial speed and a vortex convection speed of  $U_c$  using the relation  $W/U_c = 1.9/(L/C)$ . The constant 1.9 is a geometric factor resulting from the positions of the dye

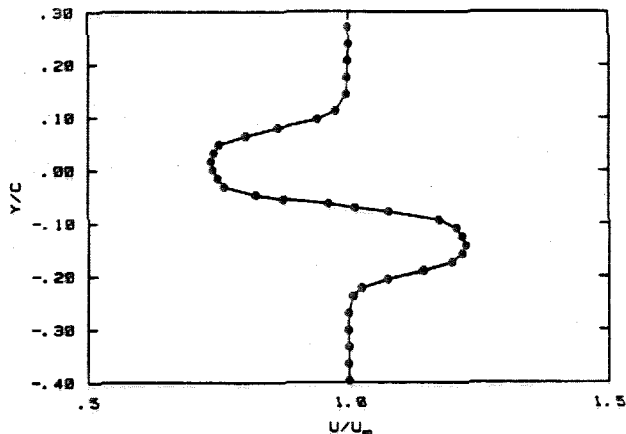
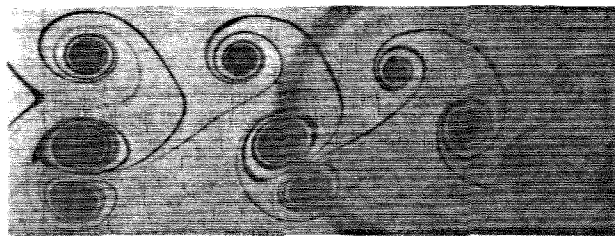
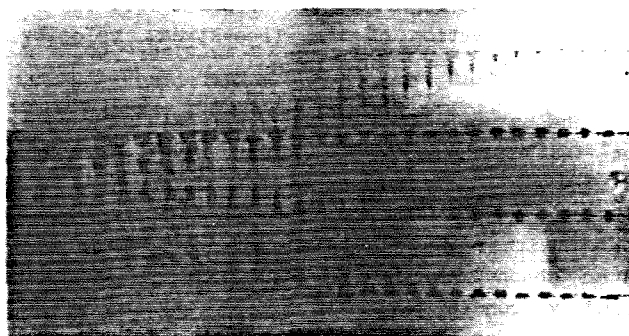
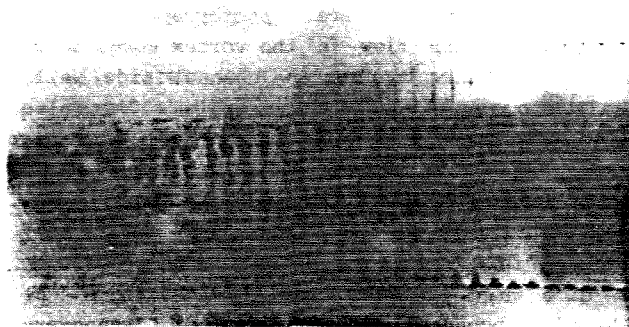

Fig. 8 Mean velocity profile at  $X/C = 1$  for the case in figure 7(a);  $S = 38\%$  and the corresponding vortex arrangement (top photo).



$A = 2 \text{ deg.}, f = 4.5 \text{ Hz}$



$A = 2 \text{ deg.}, f = 5.5 \text{ Hz}$

Fig. 9 Axial flow along vortex cores (sinusoidal oscillation).

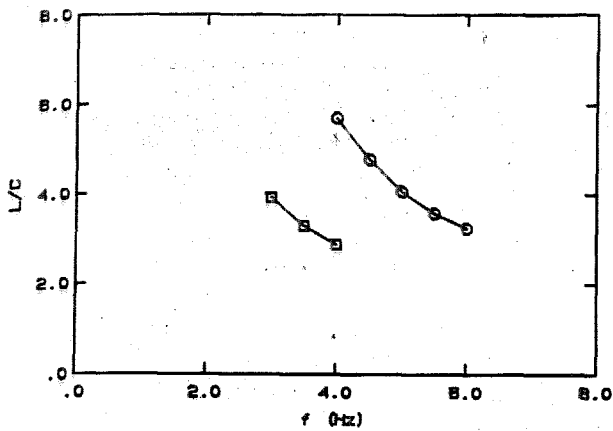

Fig. 10 Estimate of the downstream distance where the axial flow in the vortex cores reaches the channel midspan.

○ A = 2 deg. □ A = 4 deg.

streaks in the plan view picture (e.g. see figure 9). For the range of parameters studied here, the vortex convection speed  $U_c$  varies very little and is close to the free-stream speed  $U_\infty$  so that  $W/U_c$  in figure 11 is approximately equal to  $W/U_\infty$ . The data in figure 11 indicate that the magnitude of the axial speed increases almost linearly with the oscillation frequency. Comparing results at the same frequency ( $f = 4$  Hz) and two different amplitudes suggest a linear dependence on the amplitude also. It should be noted that the magnitude of the axial flow can be a sizable fraction of the free-stream velocity ( $W/U_\infty = 0.65$ ).

The nature of the vortex core axial flow is not fully understood. It is believed that the axial flow is initially generated due to the interaction of a concentrated two-dimensional vortex with a bounding wall (in this case, the water channel side walls). That the no-slip boundary condition at the wall is the major ingredient for the initiation of the axial flow is shown in figure 12. This plan view of the wake is similar to figure 9 except that only the middle two dye streaks are photographed. In figure 12(a), the flow in the vortex cores moves in the direction away from the channel side walls similar to figure 9. Upon insertion of a false wall in between these two dye streaks, figure 12(b), the flow direction is reversed. The magnitude of the axial flow appears to be the same with or without the false wall. Hence, it is only necessary that the no-slip condition be present on the side walls and the actual thickness of the side-wall boundary layers is of secondary importance. We mention here that a strong effect of side walls has also been observed in the forced wake (by oscillating one free-stream) behind the trailing edge of a splitter plate under certain

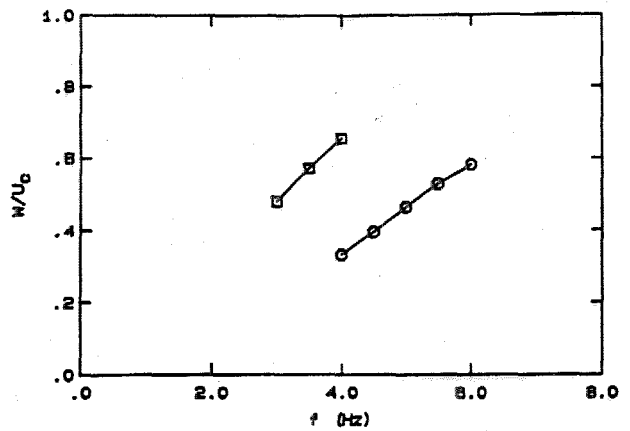
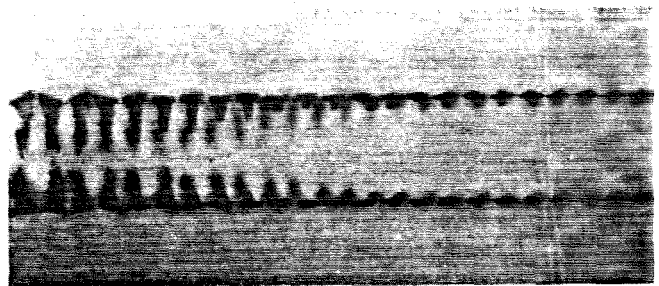
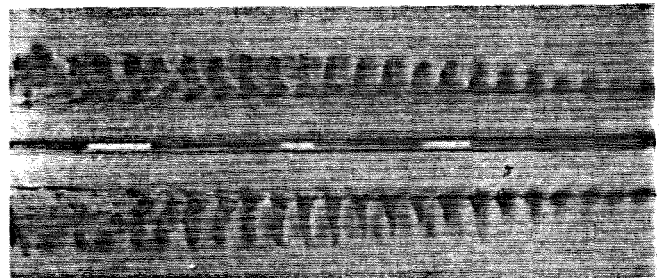

Fig. 11 Estimate of the magnitude of the axial velocity along vortex cores.

○ A = 2 deg. □ A = 4 deg.



(a) without false wall



(b) with false wall

Fig. 12 Effect of a false wall on the axial flow in the vortex cores,  $A = 2$  deg.,  $f = 4.0$  Hz, sinusoidal oscillation.

forcing conditions<sup>18</sup>. There, however, it appears that the entire flow in the channel is affected and moves away from the side walls. In the present case, the axial flow exists only within the vortex cores and the vortices themselves are not "bent away" from the side walls (see figure 9).

Once the axial flow is initiated at a wall, it seems to propagate along the core of the vortex in a wave-like manner. This feature may have a connection with the recent theoretical work of



Lundgren & Ashurst<sup>19</sup>. In figure 9, it is seen that the predominant axial flow is away from the channel side wall toward the channel mid-plane for all the vortices. We have observed cases where the direction of the axial flow depends on the sign of the circulation of the vortex. This generally happens only in the downstream region corresponding to the first few periods of oscillation and as the vortices move farther downstream the axial flow along all the vortices will move in the same direction.

### Conclusions

The structure of the wake of a pitching airfoil can be substantially modified by the control of the amplitude, frequency and also the shape of the oscillation waveform. At a given frequency and amplitude, a variety of complex vortex-vortex interactions can be generated by simply changing the shape of the waveform. It is found that the pitching airfoil in this experiment produces thrust at a higher reduced frequency than that indicated by the calculations based on the classical linear inviscid theory. In addition, the value of the critical reduced frequency for thrust generation appears to depend on the oscillation amplitude. An axial flow is observed along the core of the wake vortices. Results suggest that the magnitude of the axial flow increases approximately linearly with both the amplitude and frequency of oscillation. It is argued that the axial flow is the result of the no-slip boundary condition enforced on the wake vortices by the channel side walls. The details of this flow, particularly its wave nature, require further work.

The types of wake modification that have been demonstrated in this work need to be pursued further in order to find out their effects on the body itself (e.g. lift and drag). Furthermore, the independent control of the various parameters of the oscillation waveform provides an excellent opportunity to produce many interesting and complicated vortex patterns whose stability and interactions are worthy of study in their own right.

### Acknowledgements

I am indebted to colleagues at GALCIT for many helpful discussions, suggestions and ideas. The constant support and encouragement by Professor Paul Dimotakis and Dr. Jim McMichael are very much appreciated. Thanks are also due to

Dr. Bill Ashurst for many useful discussions. The help provided by Mr. Cliff Frieler during the experiment and also with the manuscript is gratefully acknowledged. This work was supported by the Air Force Office of Scientific Research Grant No. AFOSR-84-0120.

### References

1. Theodorsen, T., "General Theory of Aerodynamic Instability and the Mechanism of Flutter.", NACA TR 496, 1935.
2. Von Karman, T. and Sears, W. R., "Airfoil Theory for Non-Uniform Motion.", *Journal of the Aeronautical Sciences*, 5(10), 1938, pp. 379-390.
3. Lighthill, J., *Mathematical Biofluidynamics*, SIAM, 1975.
4. Wu, T. Y., "Hydromechanics of Swimming of Fishes and Cetaceans.", *Advances in Applied Mechanics*, 11, 1971, pp. 1-63.
5. Giesing, J. P., "Nonlinear Two-Dimensional Unsteady Potential Flow with Lift.", *J. Aircraft*, 5(2), 1968, pp. 135-143.
6. Djojodihardjo, R. H. and Widnall, S. E., "A Numerical Method for the Calculation of Nonlinear, Unsteady Lifting Potential Flow Problems.", *AIAA J.*, 7(10), 1969, pp. 2001-2009.
7. Vezza, M. and Galbraith, R. A. McD., "A Method for Predicting Unsteady Potential Flow about an Airfoil.", *Int. J. Numer. Methods Fluids*, 5, 1985, pp. 347-356.
8. Katzmayr, R., "Effect of Periodic Changes of Angle of Attack on Behavior of Airfoils.", NACA TM 147, 1922.
9. Silverstein, A. and Joyner, U. T., "Experimental Verification of the Theory of Oscillating Airfoils.", NACA TR 673, 1939.
10. DeLaurier, J. D. and Harris, J. M., "Experimental Study of Oscillating-Wing Propulsion.", *J. Aircraft*, 19(5), 1982, pp. 368-373.



11. Bratt, J. B., "Flow Patterns in the Wake of an Oscillating Aerofoil.", A.R.C., R & M 2773, 1953.
12. Thomas, A. S. W. and Whiffen, M. C., "Flow Visualization as an Aerodynamic Diagnostic Tool", *Lockheed Horizons*, 15, 1984, pp. 57-64.
13. Katz, J. and Weihs, D., "Behavior of Vortex Wakes from Oscillating Airfoils.", *J. Aircraft*, 15(12), 1978, pp. 861-863.
14. Von Karman, T. and Burgers, J. M., "General Aerodynamic Theory-Perfect Fluids.", Division E, vol. II, *Aerodynamic Theory* (Ed. W. F. Durand), 1943, p. 308.
15. Garrick, I. E., "Propulsion of a Flapping and Oscillating Airfoil.", NACA TR 567, 1936.
16. Aref, H., "Integrable, Chaotic and Turbulent Vortex Motion in Two-Dimensional Flows.", *Ann. Rev. Fluid Mech.*, 15, 1983, pp. 345-389.
17. Cornish, J. J., *Vortex Flows*, Lockheed-Georgia Company, 1982.
18. Roberts, F. A. and Roshko, A., "Effects of Periodic Forcing on Mixing in Turbulent Shear Layers and Wakes.", AIAA-85-0570.
19. Lundgren, T. S. and Ashurst, W. T., "Area Varying Waves on Curved Vortex Tubes.", *Bull. Am. Phys. Soc.*, 30(10), 1985, p. 1717 (paper CE6).